

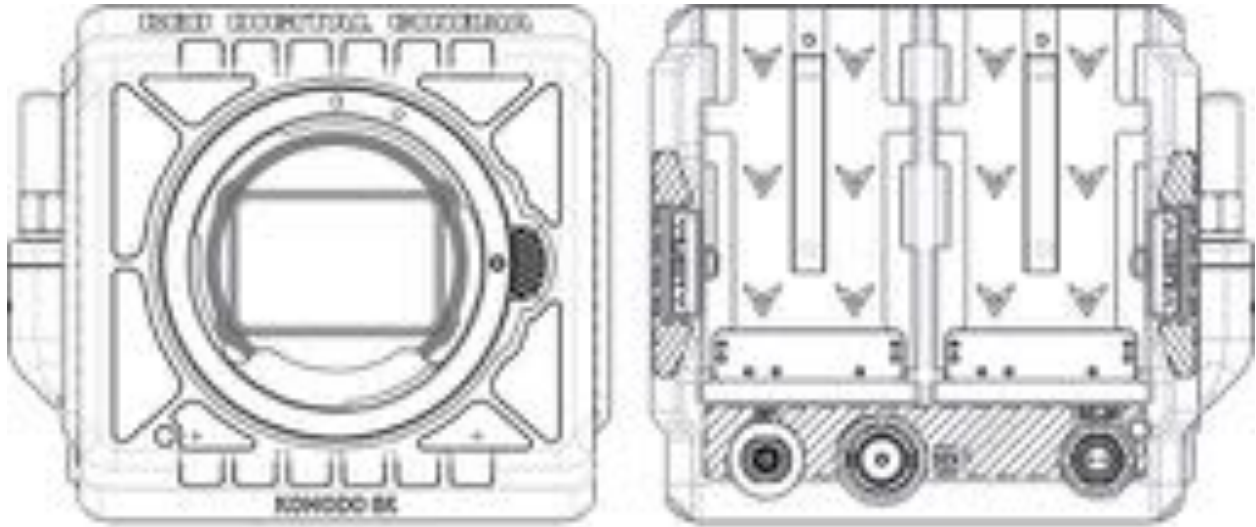

KOMODO OPERATION GUIDE



**WARNING
BETA**

KOMODO 6K S35 | V1.0 BETA

RED.COM

TABLE OF CONTENTS

DISCLAIMER	IV	PROJECT SETTINGS MENU	54
SAFETY INSTRUCTIONS	VII	FORMAT	54
1. INTRODUCTION		PROJECT TIME BASE	55
KOMODO	1	FILE FORMAT	56
2. QUICK REFERENCE		R3D QUALITY	58
PREPARING THE CAMERA HARDWARE	4	PRORES RESOLUTION	58
PREPARING THE CAMERA SYSTEM	4	PRORES CODEC	59
CONFIGURING THE SETTINGS	4	PRORES BAKED-IN SETTINGS	59
RECORDING	4	SLATE	60
PROCESSING FOOTAGE	4	AUDIO / TC MENU	61
3. CAMERA COMPONENTS		AUDIO SOURCE	62
CAMERA BODY	5	INTERNAL AUDIO	63
CAMERA BODY CONTROLS AND FEATURES	5	EXTERNAL AUDIO	64
FRONT	5	HEADPHONE	65
TOP	6	TIMECODE SOURCE	66
LEFT	7	TIMECODE DISPLAY MODE	66
RIGHT	8	MONITORING MENU	67
BACK	9	LCD	67
BOTTOM	10	SDI	69
CAMERA BODY LEDS	11	LIVE STREAM	72
BATTERIES	15	TOOLS	73
LENSES AND ADAPTORS	16	GUIDES	80
COMPATIBLE LENSES	17	MEDIA MENU	88
COMPATIBLE MOUNT ADAPTORS	17	EJECT	88
ATTACHING EF TYPE LENSES	17	MEDIA INFO	89
REMOVING EF TYPE LENSES	18	SECURE FORMAT	89
KOMODO OUTRIGGER HANDLE	18	AUTOFOCUS - BETA MENU	93
KOMODO EXPANDER MODULE	19	ENABLE	93
LCD TOUCHSCREEN	20	MODE	94
STATUS PAGE	25	SIZE	94
HISTOGRAM	26	POSITION	95
PLAYBACK	29	COMMUNICATION MENU	96
4. MENUS		CAMERA	96
IMAGE / LUT MENU	34	WIFI	97
RECORDING FRAME RATE	35	SERIAL	106
ISO	37	SYSTEM SETTINGS MENU	107
SHUTTER	38	DATE/TIME	108
WHITE BALANCE	39	LENS	109
OUTPUT COLOR SPACE	42	FAN CONTROL	111
OUTPUT TONE MAP	43	POWER	111
HIGHLIGHT ROLL-OFF	43	INDICATORS	112
DISPLAY PRESET	44	STATUS SETTINGS	113
3D LUT	45	SYSTEM STATUS	115
CDL	47	MAINTENANCE MENU	116
		CALIBRATE	117
		CALIBRATION	118
		SAVE LOG	118
		RESET DEFAULTS	119
		FACTORY RESET	120
		UPGRADE	120

5. HOW TO

WIFI CONFIGURATION121
 CONNECTING WIRELESSLY TO A DEVICE ...121
 POWER124
 ATTACHING THE BATTERIES124
 REMOVING THE BATTERIES124
 POWER COMPONENTS124
 KOMODO POWER ADAPTOR125
 AUTO BOOT ON POWER125
 POWER CONSUMPTION125
 POWER PRIORITY125
 TURNING ON THE CAMERA126
 TURNING OFF THE CAMERA127
 MEDIA MANAGEMENT127
 EJECTING MEDIA127
 INSERTING THE MEDIA129
 SECURE FORMAT131
 MEDIA INFORMATION132
 FILE SYSTEM132
 CLIP NAMING CONVENTION133
 CLIP METADATA133
 MEDIA BEST PRACTICES134
 EXPOSURE134
 FALSE COLOR EXPOSURE TOOLS136
 FOCUS137
 FOCUS PEAKING MODE137
 EDGE PEAKING MODE137
 PEAKING PEAKING MODE138
 TIMECODE138
 TIME OF DAY138
 EDGECODE139
 ZEBRA MODES141
 ZEBRA OVERVIEW141
 CALIBRATING THE SENSOR142
 WHEN TO CALIBRATE SENSOR142
 UPGRADING THE FIRMWARE142
 VERIFYING THE FIRMWARE VERSION142
 UPGRADING THE FIRMWARE142
 SYSTEM MAINTENANCE143
 EXTERIOR SURFACES144
 STORAGE144
 LCD SCREEN144
 WATER DAMAGE144

6. TROUBLESHOOTING

GENERAL TROUBLESHOOTING TIPS145
 CONTACT SUPPORT145

7. MECHANICAL DRAWINGS

FRONT VIEW146
 BACK VIEW147
 RIGHT SIDE VIEW147
 LEFT SIDE VIEW148

TOP VIEW149
 BOTTOM VIEW150
 EXTENSION PORT151
 9-PIN 0B ODU AUXILIARY PORT PINOUT ...151
 DC-INPUT152
 SPECIFICATIONS152
 CTRL (RS-232 CONTROL)153
 SPECIFICATIONS153
8. MENU MAP154

DISCLAIMER

RED® has made every effort to provide clear and accurate information in this document, which is provided solely for the user's information. While thought to be accurate, the information in this document is provided strictly "as is" and RED will not be held responsible for issues arising from typographical errors or user's interpretation of the language used herein that is different from that intended by RED. All safety and general information is subject to change as a result of changes in local, federal or other applicable laws.

RED reserves the right to revise this document and make changes from time to time in the content hereof without obligation to notify any person of such revisions or changes. In no event shall RED, its employees or authorized agents be liable to you for any damages or losses, direct or indirect, arising from the use of any technical or operational information contained in this document.

This document was generated on 7/27/2020. To see earlier versions of this document, submit a Support ticket at <https://support.red.com>. For comments or questions about content in this document, send a detailed email to OpsGuides@red.com.

COPYRIGHT NOTICE

COPYRIGHT© 2020 RED.COM, LLC

All trademarks, trade names, logos, icons, images, written material, code, and product names used in association with the accompanying product are the copyrights, trademarks, or other intellectual property owned and controlled exclusively by RED.COM, LLC. For a comprehensive list, see www.red.com/trademarks.

TRADEMARK DISCLAIMER

All other company, brand, and product names are trademarks or registered trademarks of their respective holders. RED has no affiliation to, is not associated with or sponsored by, and has no express rights in third-party trademarks. Adobe and Adobe Premiere Pro are registered trademarks of Adobe Systems Incorporated. AJA is a registered trademark of AJA Video Systems, Inc. Cooke and S4/i are registered trademarks of Cooke Optics Limited. DaVinci is a registered trademark of Blackmagic Design in the U.S. and other countries. Distagon, Makro-Planar, and Otus are registered trademarks of Carl Zeiss AG. Fujinon is a registered trademark of FUJIFILM CORPORATION. HDMI is a registered trademark of HDMI Licensing LLC in the United States and other countries. Leica is a registered trademark of Leica Microsystems. Loctite is a registered trademark of Henkel AG & Company KGaA. Nikkor and Nikon are registered trademarks of Nikon Corporation. Canon is a registered trademark of Canon, U.S.A. Apple, Macintosh, Final Cut Pro, and QuickTime are registered trademarks of Apple Inc. in the U.S. and other countries. Windex is a registered trademark of S. C. Johnson & Son, Inc. Windows is a registered trademark of Microsoft Corporation. Sony is a registered trademark of Sony Corporation. TORX is a registered trademark of Acument Intellectual Properties, LLC in the United States or other countries. IOS is a registered trademark of Cisco in the U.S. and other countries. Avid is a registered trademark of Avid Technology, Inc. DaVinci Resolve is a registered trademark of Blackmagic Design in the U.S. and other countries. EDIUS Pro is a registered trademark of Grass Valley. Vegas Pro is a registered trademark of Sony Creative Software. IDX is a registered trademark of IDX Company, Ltd.

COMPLIANCE STATEMENTS

INDUSTRIAL CANADA EMISSION COMPLIANCE STATEMENTS

This device complies with Industry Canada license-exempt RSS standards RSS 139 and RSS 210. Operation is subject to the following two conditions: (1) this device may not cause interference, and (2) this device must accept any interference, including interference that may cause undesired operation of the device.

This Class B digital apparatus complies with Canadian ICES-003. To comply with FCC and Industry Canada RF exposure limits for general population/ uncontrolled exposure, the antenna(s) used for this transmitter must be installed to provide a separation distance of 70mm from all persons and operating in conjunction with any other antenna or transmitter, except in accordance with FCC multi-transmitter product procedures.

Other user manual statements may apply.

Le présent appareil est conforme aux CNR d'Industrie Canada applicables aux appareils radio exempts de licence. L'exploitation est autorisée aux deux conditions suivantes : (1) l'appareil ne doit pas produire de brouillage, et (2) l'utilisateur de l'appareil doit accepter tout brouillage radioélectrique subi, même si le brouillage est susceptible d'en compromettre le fonctionnement.

Cet appareil numérique de la classe B est conforme à la norme NMB-003 du Canada.

Pour se conformer aux limites d'exposition aux RF de la FCC et d'industries Canada pour la population générale/ exposition non contrôlée, l'antenne(s) utilisée pour ce transmetteur doit être installée pour fournir une distance de séparation d'au moins 70mm de toutes les personnes et fonctionnant conjointement avec une autre antenne ou émetteur, sauf en conformité avec les procédures de produits multi-émetteur FCC.

Autres d'éclairations manuel de l'utilisateur peuvent s'appliquer.

FEDERAL COMMUNICATIONS COMMISSION (FCC) STATEMENTS



This equipment has been tested and found to comply with the limits for a Class B digital device, pursuant to part 15 of the FCC Rules. These limits are designed to provide reasonable protection against harmful interference in a residential installation. This equipment generates, uses and can radiate

radio frequency energy and, if not installed and used in accordance with the instructions, may cause harmful interference to radio communications. However, there is no guarantee that interference will not occur in a particular installation. If this equipment does cause harmful interference to radio or television reception, which can be determined by turning the equipment off and on, the user is encouraged to try to correct the interference by one or more of the following measures:

- ▶ Reorient or relocate the receiving antenna.
- ▶ Increase the separation between the equipment and the receiver.
- ▶ Connect the equipment to an outlet on a circuit different from that to which the receiver is connected.
- ▶ Consult the dealer or an experienced radio/TV technician for help.

To maintain compliance with FCC regulations, shielded cables must be used with this equipment. Operation with non-approved equipment or unshielded cables is likely to result in interference to radio and TV reception. The user is cautioned that changes and modifications made to the equipment without the approval of manufacturer could void the users authority to operate this equipment.

NOTE: This device complies with Part 15 of the FCC Rules. Operations subjected to the following two conditions (1) this device may not cause harmful interference, and (2) this device must accept any interference received, including that which may cause undesirable interference.



CAUTION: Exposure to Radio Frequency Radiation.

The device shall be used in such a manner that the potential for human contact is minimized.

This equipment complies with FCC radiation exposure limits set forth for an uncontrolled environment. This equipment should be installed and operated with a minimum distance of 20 cm between the radiator and your body.



CAUTION: Regulations of the FCC and FAA prohibit airborne operation of radio-frequency wireless devices because their signals could interfere with critical aircraft instruments.



CAUTION: If the device is changed or modified without permission from RED, the user may void his or her authority to operate the equipment.

AUSTRALIA AND NEW ZEALAND STATEMENTS

RED declares that the radio equipment described in this document complies with the following international standards:

- ▶ IEC 62368-1 – Product Safety
- ▶ ETSI EN 300 328 – Technical requirement for radio equipment

RED declares digital devices described in this document comply with the following Australian and New Zealand standards:

- ▶ AS/NZS CISPR 22 – Electromagnetic Interference
- ▶ AS/NZS 61000.3.2 – Power Line Harmonics
- ▶ AS/NZS 61000.3.3 – Power Line Flicker

JAPAN STATEMENTS

This equipment contains specified radio equipment that has been certified to the Technical Regulation Conformity Certification under the Radio Law.

本機器は、電波法に基づく技術基準適合証明等を受けた特定無線デバイスを使用しております。



® 201-180720

EUROPEAN UNION COMPLIANCE STATEMENTS



RED declares that the radio equipment described in this document complies with the EMC Directive (2014/30/EU) and the Low Voltage Directive (2014/35/EU) issued by the Commission of the European Community. Compliance with this directive implies

conformity to the following European Norms (in brackets are the equivalent international standards).

- ▶ EN 62368-1 (IEC 62368-1) – Product Safety
- ▶ ETSI EN 300 328 Technical requirement for radio equipment
- ▶ ETSI EN 301 489 General EMC requirements for radio equipment
- ▶ EN 55032 (CISPR 32) Electromagnetic Compatibility
- ▶ EN 55035 (CISPR 35) Immunity Requirements
- ▶ EN 61000-3-2 (IEC 61000-3-2) Harmonic Current Emissions
- ▶ EN 61000-3-3 (IEC 61000-3-3) Voltage changes, voltage fluctuations and flicker
- ▶ EU 2015/863 RoHS Directive

WASTE ELECTRICAL AND ELECTRONIC EQUIPMENT (WEEE)

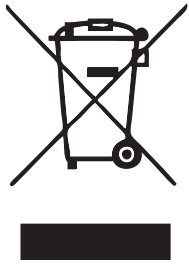

The Waste Electrical and Electronic Equipment (WEEE) mark applies only to countries within the European Union (EU) and Norway. This symbol on the product and accompanying documents means that used electrical and electronic products should not be mixed with general household waste. For proper treatment, recovery and recycling, take this product to designated collection points where it will be accepted free of charge. Alternatively, in some countries you

may be able to return your products to your local retailer upon purchase of an equivalent new product.

Disposing of this product correctly will help save valuable resources and prevent any potential negative effects on human health and the environment, which could otherwise arise from inappropriate waste handling. Contact your local authority for further details of your nearest designated collection point. Penalties may be applicable for incorrect disposal of this waste, in accordance with your national legislation.

For business users in the European Union, if you wish to discard electrical and electronic equipment, contact your dealer or supplier for further information.

RESPONSIBLE PARTY

RED Digital Cinema
34 Parker
Irvine, CA 92618
USA

SAFETY INSTRUCTIONS

- ▶ DO NOT use the camera or accessories near water. Avoid exposing your camera to moisture. The unit is not waterproof, so contact with water could cause permanent damage to the unit as well as electric shock and serious injury to the user. DO NOT use the camera in the rain or under other conditions with high moisture without appropriate protection, and immediately remove power source if camera or accessories are exposed to moisture.



WARNING: To reduce the risk of fire or electric shock, do not expose the camera to rain or moisture.

- ▶ DO NOT expose the camera to laser beams, as laser beams may damage the sensor.
- ▶ DO NOT expose your camera to excessive vibration or impact (shock). Be careful not to drop your camera. Internal mechanisms may be damaged by severe shock. Mechanical alignment of optical elements may be affected by excessive vibration.
- ▶ ELECTROMAGNETIC INTERFERENCE: The use of devices using radio or other communication waves may result in the malfunction or interference with the unit and/or with audio and video signals.
- ▶ Clean only using a dry cloth. When cleaning your camera, remember that it is not waterproof and moisture can damage electronic circuitry. DO NOT rinse or immerse any element of the camera, lens or other accessory, keep them dry at all times. DO NOT use soaps, detergents, ammonia, alkaline cleaners, and abrasive cleaning compounds or solvents. These substances may damage lens coatings and electronic circuitry.
- ▶ Maintain sufficient ventilation—DO NOT block any ventilation openings or obstruct cooling fan airflow.



CAUTION: Proper camera ventilation requires a minimum 0.5" (1.25 cm) clearance between the camera ventilation openings and external surfaces. Verify that objects that can block the fan intake and exhaust ports do not impede airflow. Failure to permit adequate airflow may result in overheating of the camera, degraded operation and in extreme situations, damage to the camera.



WARNING: CFast media cards can become very hot during prolonged recording sessions. When ejecting the CFast media card, let it cool before touching it with bare fingers.

- ▶ DO NOT operate or store near any heat sources such as radiators, heat registers, stoves, or any other apparatus that produce heat. Store in a protected, level and ventilated place. Avoid exposure to temperature extremes, damp, severe vibration, strong magnetic fields, direct sunlight or local heat sources during storage. Remove any batteries from the camera before storage. Recommended storage and usage temperatures for your camera, lenses and other accessories are:
 - ▶ Operating range: 0° C to 40° C (32° F to 104° F)
 - ▶ Storage range: -20° C to 50° C (-4° F to 122° F)

- ▶ If there are any performance issues with your camera or accessories when operating within this temperature range, submit a Support ticket at <https://support.red.com>.
- ▶ DO NOT bypass the third prong of the grounding-type plug on the power cord of the included power Adaptor. A grounding-type plug has two blades and a third “grounding” prong. The third prong is provided for your safety. You must connect the plug to an outlet with a protective earthen connection. If the grounding-type plug does not fit into your outlet, do not attempt to modify the plug or outlet, consult a qualified electrician.
- ▶ Protect all power cords from being pinched, walked on, or driven over by a vehicle. Replace any power cords suspected of sustaining damage due to crushing or other forms physical damage.



CAUTION: Install this camera in a proper support system that can handle the entire weight of the camera and the accessories. Secure the camera by using the ¼-20 and/or the 3/8-16 mounting points located on the bottom of the camera or on the Expander Module. Always verify that the screws are tightened properly. When the camera is not properly attached, or is placed on an unstable surface, the camera can fall and cause injury or be damaged.



CAUTION: Products marked with this symbol are class 2 devices. These devices are not provided with a grounding type plug.



CAUTION: The power cord plug for the included power adaptor is used as the power disconnect. To disconnect all power from the power adaptor, unplug the power cord plug from the wall outlet. During use, the power cord plug should remain easily accessible at all times.

- ▶ Lithium-ion batteries may be subject to special handling requirements pursuant to federal and local laws. Refer to specific shipping instructions included with your battery regarding proper transport of your battery. Do not handle your battery if it is damaged or leaking. Disposal of batteries must be in accordance with local environmental regulations. For example, California law requires that all rechargeable batteries must be recycled by an authorized recycle center. Storing batteries fully charged or in high temperature conditions may permanently reduce the life of the battery. Available battery capacity may also be temporarily lessened after storage in low temperature conditions.



WARNING: DO NOT expose the battery to excessive heat.



CAUTION: Refer all service and repair to qualified RED service personnel. To reduce the risk of electric shock, and damage to the camera or accessories, DO NOT attempt to perform any servicing other than any procedures that are recommended in the operating instructions.



INDOOR USE ONLY: This device is designed for use indoors only.

BATTERY STORAGE AND HANDLING

WARNING: Failure to read, understand, and follow these instructions may result in overheating, chemical leakage, smoke emission, fire, or other potentially harmful results.

- ▶ Read and adhere to all safety instructions provided by the manufacturer of the batteries.
- ▶ Always follow proper battery handling and storage practices. Improper handling and failure to abide by proper storage instructions may cause permanent damage to batteries, or degrade battery charge holding capacity. Improper handling practices or failure to comply with instructions may also put you at risk.
- ▶ Lithium-Ion batteries, like the Canon BP-900 series, self-discharge over time. When storing for long periods of time, store batteries separately from the camera or charger and remember to charge batteries to a capacity level of 40% to 60%. If batteries will be stored for long periods of time, RED recommends that you check the charge level at least once every six (6) months, and recharge batteries to a capacity level of 40% to 60%.
- ▶ When not in use, remove the battery from the camera or charger and store the battery in a cool, dry place. Avoid extreme hot temperatures (such as inside a hot car), corrosive gas, and direct sunlight. The optimal storage temperature for batteries is between -20° C to 20° C (-4° F to 68° F).



WARNING: Batteries stored in a discharged state for long periods of time may self-discharge and lose the ability to hold a charge.



WARNING: If recharging operation fails to complete even when a specified recharging time has elapsed, immediately stop further recharging.

- ▶ DO NOT allow the battery to get wet.
 - ▶ DO NOT pierce the battery with pointed or other sharp objects.
 - ▶ DO NOT step on, throw, or strike the battery with a hammer.
 - ▶ DO NOT use a battery that appears to be deformed or damaged.
 - ▶ DO NOT directly solder the battery.
 - ▶ DO NOT put the battery into a microwave oven or a pressurized container.
 - ▶ DO NOT use or subject the battery to intense sunlight or hot temperatures such as in a car in hot weather.
 - ▶ DO NOT use it in a location where static electricity may be present.
 - ▶ DO NOT exceed the recharging temperature range of 0° C to 40° C (32° F to 104° F).
 - ▶ Store the battery in a location where children cannot reach it.
 - ▶ If the battery leaks or gives off a bad odor, discontinue use immediately.
 - ▶ If the battery gives off an odor, generates heat, becomes discolored or deformed, or in any way appears abnormal during use, recharging or storage, immediately remove it from the equipment or battery charger and discontinue use.
 - ▶ If electrolyte begins leaking from the battery and comes into contact with your skin or clothing, immediately wash it away with running water. Failure to do this may result in skin inflammation.
 - ▶ If the battery leaks and the electrolyte reaches the eyes, do not rub them. Instead, rinse the eyes with clean running water and immediately seek medical attention. Failure to do this may result in eye injury.
- ▶ DO NOT store batteries in a fully charged state for extended periods of time.
 - ▶ DO NOT store batteries in a fully discharged state for extended periods of time.
 - ▶ DO NOT store batteries in the camera or in a charger for extended periods of time.
 - ▶ DO NOT use batteries for purposes other than their intended use.
 - ▶ DO NOT store batteries in extreme hot or cold temperatures.
 - ▶ DO NOT store batteries in direct sunlight.
 - ▶ DO NOT disassemble or modify the battery.
 - ▶ DO NOT overcharge batteries. Overcharging may increase internal temperature beyond the recommended limits and cause permanent damage to the battery.
 - ▶ DO NOT connect the positive (+) and negative (-) terminals to a metal object such as a wire.
 - ▶ DO NOT transport or store the battery together with metal objects such as jewelry, hairpins, etc. as they may generate heat if they come into contact with the battery.
 - ▶ DO NOT discard the battery into fire or heat.
 - ▶ DO NOT store, use, or recharge the battery near a heat source such as a fire or a heater.

1. INTRODUCTION



Figure: KOMODO camera

KOMODO

KOMODO 6K is the latest breakthrough product in RED's long line of innovative image capture technology. The newest entrant into the RED lineup is a compact, all-in-one, and highly powerful cinema camera. It features RED's cinema grade image quality, color science, and sensor technology in a portable form factor cinematographers can take anywhere and adapt to any shooting scenario.

The new sensor in KOMODO is a 6K S35 global shutter sensor. This sensor breaks new technical ground by retaining wide dynamic range and delivering unmatched RED imagery, without compromising creative or technical features. KOMODO includes a built-in Canon RF-style mount allowing users the flexibility to use several lens Adaptors, such as Canon EF, PL, and Leica M mount.

The KOMODO records using R3D or ProRes formats written to a CFast 2.0 media card. The RED KOMODO is powered by batteries or a power cable. Control the KOMODO features with the top **LCD Touchscreen**, or you can use the screen to watch playback.

QUICK REFERENCE

Refer to the **Quick Reference** section to get familiar with this guide and the camera.

R3D FILE FORMAT AND REDCODE

All videos and frames are recorded to the R3D[®] file format. The R3D file format was developed by RED to provide an efficient and manageable RAW video data format that promotes advanced post production editing capabilities. In the R3D file format, the digital image received from the sensor is formatted as a pixel-defect corrected (but in all other aspects unprocessed) 16-bit per pixel RAW data frame. Each RAW frame, or sequence of RAW frames in a clip, is compressed using proprietary REDCODE[®] RAW compression, then stored to media.

RAW data is recorded independently of any RGB domain color processing such as ISO, White Balance, or other RGB color space settings. Instead, color parameters are saved as reference metadata; that is, color is not burned into the recorded RAW data. This recording technique promotes flexibility in RGB color processing, which can be deferred to post production or adjusted in the field, without affecting the recorded RAW data image quality or dynamic range.

REDCODE is a compression codec that reduces R3D RAW files into a manageable size, allowing longer recording times on media. The ability to compress RAW data is one of the significant technologies that RED has brought to the industry.

NOTE: REDCINE-X PRO[®] can create and export .RMD “Look” files, which you can import as monitor path color processing presets. This information is stored as reference metadata, so that these color processing choices can be the default values used in post production.

GLOBAL SHUTTER

This camera employs Global Shutter technology. This technology exposes all of the sensor's pixels in each frame simultaneously, unlike a rolling shutter that exposes lines of pixels (each with a delay) causing image artifacts on fast-moving objects. Global Shutter technology not only improves the visual appearance of this camera's images, it also eliminates tracking and matte-painting distortions during post production.

IMAGE PROCESSING PIPELINE

This camera uses the new RED Image Processing Pipeline 2 (IPP2). In IPP2, the camera applies REDWideGamutRGB, which is a color space designed to encompass all colors a RED camera can generate without clipping. The camera then encodes the image using Log3G10, a gamma curve that prevents clipping. Using this color space and gamma curve allows you to grade and make color adjustments in post production, instead of in-camera. IPP2 enables the camera to use **CDL** for grading. For more information refer to the **RED IPP2** support page.

SHOOT FOR VIDEO AND STILLS

High resolution video, such as the digital footage captured by the camera, has surpassed the detail necessary to produce professional full-sized prints. Because of the ability to record at high frame rates and resolution, the camera is ideally suited to capture video and still images, simultaneously.

POST PRODUCTION

Many non-linear editing systems (NLEs) can open and edit RED footage. Each NLE version may have specific compatibility requirements, such as camera firmware version or camera type. Before shooting, check all compatibility requirements.

The following programs can be used to open and/or edit R3D files:

- ▶ **REDCINE-X PRO:** RED's proprietary application. Download [REDCINE-X PRO for Windows](#) or [REDCINE-X PRO for Mac](#) from www.red.com/downloads.
- ▶ **Adobe Premiere Pro**
- ▶ **Avid Media Composer**
- ▶ **DaVinci Resolve**
- ▶ **Edius Pro**
- ▶ **Final Cut Pro X:** Requires you to download the [RED Apple Workflow Installer](#) from www.red.com/downloads.
- ▶ **Vegas Pro**
- ▶ **Adobe Photoshop:** Can open .R3D files, however, you must download the [RED Adobe Photoshop Installer for Windows](#) or [RED Adobe Photoshop Installer for Mac](#) from www.red.com/downloads.

NOTE: Third-party applications may have limited compatibility with R3D files. Third-party developers must use the most recent [R3D SDK](#) to offer compatibility with the latest RED firmware.

POST PRODUCTION WITH REDCINE-X PRO

REDCINE-X PRO is a professional one-light coloring tool set, equipped with an integrated time line, and with a collection of post effects software. These tools provide the ideal environment to review recorded footage, edit metadata, organize projects, and prepare your R3D files. You can use REDCINE-X PRO or any of the compatible third-party NLEs to edit R3D files.

ADDITIONAL RESOURCES

- ▶ **RED.com:** Check the [official RED website](#) for the latest information about RED products.
- ▶ **RED Downloads:** Go to [RED Downloads](#) to download the latest firmware, operation guides, and post production software.
- ▶ **RED 101 Articles:** RED offers [in-depth technical articles](#) about RED cameras, post production, and digital cinematography.
- ▶ **RED TECH Videos:** RED offers [videos](#) about understanding and using RED cameras.
- ▶ **RED Support:** Check the [RED SUPPORT site](#) for support articles or to file a support ticket.

2. QUICK REFERENCE

Congratulations new RED KOMODO camera owner. This quick reference topic helps you quickly get familiar with this guide and the **Camera Body**. It includes links to topics about configuring the camera to fit your recording requirements, and for learning the basic operation of the camera.

PREPARING THE CAMERA HARDWARE

Prepare the camera hardware for recording by:

- ▶ Installing compatible **Lenses and Adaptors**
- ▶ **Inserting the Media**
- ▶ Connecting a power source (refer to **Power** or **KOMODO Power Adaptor**)
- ▶ **Turning On the Camera**

PREPARING THE CAMERA SYSTEM

Configure the camera settings to prepare for recording (refer to the **System Settings Menu**).

CONFIGURING THE SETTINGS

- ▶ Configuring the camera system settings
- ▶ **Upgrading the Firmware**
- ▶ Calibrating the camera using the **Calibrate** option
- ▶ Formatting the media (refer to **Secure Format**)
- ▶ Specifying the desired recording resolution (refer to **Format**)
- ▶ Configuring the **Recording Frame Rate**
- ▶ Setting the exposure (refer to **Shutter**)
- ▶ Configuring the monitoring tools and reviewing the monitored image (refer to the **Monitoring Menu**)
- ▶ Reviewing the camera status (refer to **System Status**)

RECORDING

Start recording your project.

- ▶ Record by pressing the REC button on the **Camera Body**
- ▶ Record by using the **LCD Touchscreen**

PROCESSING FOOTAGE

Perform post-production using any of the standard applications.

- ▶ Adobe® Premiere® Pro
- ▶ Avid® Media Composer®
- ▶ DaVinci Resolve®
- ▶ Final Cut Pro X®

3. CAMERA COMPONENTS

CAMERA BODY

This section describes the **Front**, **Top**, **Left**, **Right**, **Back**, and **Bottom** of the camera, and identifies the controls, buttons, **Camera Body LEDs**, and the lens mount on the body.

CAMERA BODY CONTROLS AND FEATURES

This section describes the controls and features of the camera.

FRONT



Figure: Camera Body Front Controls and Features

#	ITEM	DESCRIPTION
1	Lens mount	Lens mount for RF type (refer to Lenses and Adaptors)
2	Mic 1	Left Internal Audio channel
3	Mic 2	Right Internal Audio channel
4	Tally Light	Tally light (refer to Camera Body LEDs and Indicators)

TOP



Figure: Camera Body Top Controls and Features

#	ITEM	DESCRIPTION
1	LCD Touchscreen	Camera LCD Touchscreen
2	MENU (BACK) Button	Menu button, Back button
3	Up Arrow (LOCK) Button	Navigates up in the menu and locks/unlocks the UI when pressed along with the other Lock button
4	Down Arrow (LOCK) Button	Navigates down in the menu and locks/unlocks the UI when pressed along with the other Lock button
5	Select (FN) Button	Selects the highlighted menu item and enables the (Function) buttons
6	Right Arrow Button	Opens the Playback screen
7	1/4-20 Mounting Holes	1/4-20 mounting holes for optional accessories (refer to KOMODO Outrigger Handle)
8	Accessory Port	Connection port for accessories (refer to KOMODO Outrigger Handle)

LEFT



Figure: Camera Body Left Controls and Features

#	ITEM	DESCRIPTION
1	External Mic Jack	3.5 mm stereo microphone input
2	Headphone Jack	3.5 mm stereo headphone output
3	Media Bay	CFast 2.0 media bay
4	CFast LED	CFast status indicator (refer to Camera Body LEDs)
5	EJECT Button	Left battery release button
6	M4 Mounting Holes	Two (2) M4 mounting points for accessories
7	Focus Plane	Focus plane indicator symbol
8	Beep Speaker	Camera beep speaker

RIGHT



Figure: Camera Body Right Controls and Features

#	ITEM	DESCRIPTION
1	Power LED	Displays the camera ready status (refer to Camera Body LEDs)
2	ON/OFF Switch	Slide up to turn on the camera and slide down to turn off the camera
3	EJECT Button	Right battery release button
4	Wireless Antenna	WiFi antenna with SMA connector. Supports 2.4 GHz and 5 GHz
5	REC button	Press and release the PWR/REC button to toggle between record start and stop.
6	Record LED	Displays the camera recording status (refer to Camera Body LEDs)
7	Air Intake	Air intake for thermal management
8	Focus Plane	Focus plane indicator symbol
9	M4 Mounting Holes	Two (2) M4 mounting points for accessories

BACK



Figure: Camera Body Rear Controls and Features

#	ITEM	DESCRIPTION
1	Battery mounts	Two mounts for the batteries (refer to Batteries)
2	Eject buttons	Right and left battery release buttons
3	9-Pin Extension Port	9-pin 0B ODU port (refer to KOMODO Expander Module)
4	12G- SDI port	Full-size 12G-SDI BNC port for SDI monitor connection
5	2-pin DC-Input port	2-pin 0B ODU for DC-IN with wide input voltage support (7-17 Volts)
6	DC-IN/Battery LED	Displays the camera power status (refer to DC/Battery LED)

BOTTOM



Figure: Camera Body Bottom Controls and Features

#	ITEM	DESCRIPTION
1	Mounting Points	One (1) 1/4"-20 mounting hole and one (1) 3/8"-16 mounting hole (refer to KOMODO Expander Module)
2	Registration Points	Indented alignment points for the KOMODO Expander Module
3	Service Port	For RED service only - DO NOT REMOVE

CAMERA BODY LEDS

FRONT LED



Figure: KOMODO 6K LED, Front

#	ITEM	COLOR	DESCRIPTION
1	Tally Indicator LED	Red	When enabled, this LED is ON when the camera is recording. For information about enabling this LED, refer to Indicators .

LEFT SIDE LED



Figure: KOMODO 6K LED, Left Side

#	ITEM	COLOR/FLASHING	DESCRIPTION
1	CFast Media LED	Off	No media mounted
		Green	Preview; media mounted with > 10% of media space available
		Amber	Recording finalizing or playback mode
		Amber flashing slow	Formatting media
		Red flashing slow	Media mounted with >5% and <= 10% of media space available
		Red flashing fast	Media mounted with <= 5% of media space available
		Red	Recording

RIGHT SIDE LEDS



Figure: KOMODO 6K LED, Right Side

#	ITEM	COLOR/FLASHING	DESCRIPTION
1	Power Status (ON)	Off	Camera OFF
		Amber	Camera booting
		Green	Camera ON
		Amber flashing	Camera on; 5 to 10 min of battery time available
		Red flashing	Camera on; < 5 min of battery time available
		Red	Camera shutting down
2	Record Status (REC)	Off	No media present
		Green	Ready to record
		Red	Recording
		Amber	Finalizing
		Red flashing slow	Media mounted with >5% and <= 10% of media space available
		Red flashing fast	Media mounted with <= 5% of media space available
	Power and Record	Both flashing green	Firmware update in progress
		Both flashing red	Firmware update error (refer to Upgrading the Firmware)

DC/BATTERY LED



Figure: KOMODO 6K, DC/Battery LED

#	ITEM	COLOR	DESCRIPTION
1	DC-IN	Green	DC-IN is present and / or the battery is fully charged
		Amber	Charging connected batteries
		Red	Error charging the batteries

BATTERIES

The camera has two battery slots for Canon BP-900 series batteries. The left battery slot (facing the back of the camera) has priority over the right battery slot. Refer to **Power Priority** for more information.

The camera charges the batteries when the camera is off and a power cable is connected. Recharging two batteries takes approximately eight hours.

The recommended models of Canon batteries include:

CANON BP-955	CANON BP-975
Battery Type: Rechargeable Lithium-Ion battery	Battery Type: Rechargeable Lithium-Ion battery
Operating Temperature: 32° - 104° F (0° - 40° C)	Operating Temperature: 32° - 104° F (0° - 40° C)
Rated Voltage: 7.4 V DC	Rated Voltage: 7.4 V DC
Capacity: 5200 mAh typical / 4900 mAh (37 Wh) minimum	Capacity: 7800 mAh typical / 7350 mAh (55 Wh) minimum
Dimensions: Width=1.504", Height=2.773", Depth=1.7"	Dimensions: Width=1.504", Height=2.773", Depth=2.45"
Weight: 7.8 ounces	Weight: 11.3 ounces



4 LEDs indicate the remaining battery life.



As much as 50% more recording time than the BP-955.
4 LEDs indicate the remaining battery life.

WARNING: Use of genuine Canon batteries is recommended.

WARNING: This product is designed to achieve optimum performance when used with genuine Canon BP-955 and BP-975 batteries.

RED shall not be liable for any damage to this product and/or accidents such as malfunction, fire, etc., caused by the failure of non-genuine Canon batteries (e.g., a leakage and/or explosion of a battery pack). Please note that repairs arising out of the malfunction of non-genuine batteries will not be covered by the warranty for repairs.

Using the batteries with an incompatible battery charger or product may result in malfunction or accidents for which RED cannot be held liable.

LENSES AND ADAPTORS

This section lists the compatible lenses and Adaptors for the camera. It also provides the steps for **Attaching EF Type Lenses** and **Removing EF Type Lenses** with an attached RF mount Adaptor.

For more information on a specific lens or Adaptor, refer to the original manufacturer's instructions.

WARNING: When the camera is not in use, protect lenses and the camera sensor by replacing the lens caps and camera mount cap.



Figure: Camera with mount cap installed.

Incompatible lenses do not register on the camera UI and they will not show any UI lens information or menu controls. The camera can control compatible lenses electronically, including the following features:

- ▶ Aperture - The UI menu is enabled and the camera can control the lens aperture
- ▶ Autofocus - The UI menu is enabled for lenses that support autofocus.
- ▶ Image Stabilization - The UI indicates that image stabilization is present.

For more information, refer to the **Lens** menu.

COMPATIBLE LENSES

RED tested the following lenses and determined that they are compatible with the camera:

- ▶ Canon EF 14mm f/2.8L II USM
- ▶ Canon EF 24mm f/1.4L II USM
- ▶ Canon EF 35mm f/1.4L II USM
- ▶ Canon EF 50mm f/1.2L USM
- ▶ Canon EF 85mm f/1.2L II USM
- ▶ Canon EF-S 17-55 f/2.8 IS USM
- ▶ Canon EF 24-70 f/2.8L II USM
- ▶ Canon EF 16-35 f/2.8L III USM
- ▶ Canon EF 24-105 f/4L IS II USM
- ▶ Canon EF 70-200mm f/2.8L IS III USM

NOTE: While RF type lenses can mount directly to the camera, they are not supported at this time.

For the latest information about compatible KOMODO lenses, refer to [RED.com](https://www.red.com).

LENS WEIGHT AND LENS SUPPORT

Use a lens support system when mounting heavy or long lenses to your camera.

When mounting a heavy or long lens, ensure that the full weight of the lens is never directly on the camera or lens mount. Mount the lens to the support system first, and then carefully mount the lens to the camera.

COMPATIBLE MOUNT ADAPTORS

RED tested the following Adaptors and determined that they are compatible with the camera:

- ▶ Canon Mount Adaptor EF-EOS R
- ▶ Canon Drop-In Filter Mount Adaptor EF-EOS R with Variable ND Filter / Clear Filter / Circular Polarizer

For the latest information about compatible KOMODO lens Adaptors, refer to [RED.com](https://www.red.com).

ATTACHING EF TYPE LENSES

1. Make sure that the EF-EOS R Adaptor is attached to the camera.
2. Remove the mount cap from the EF-EOS R Adaptor.
3. Remove the mount cap from the mount end of the lens.
4. Align the red dots and insert the EF lens in the EF-EOS R Adaptor.
5. Turn the lens clockwise until it clicks in place.
6. Store the lens and adaptor caps.

REMOVING EF TYPE LENSES

1. Press and hold the lens release button on the EF-EOS R Adaptor. While holding the lens release button, turn the lens counter-clockwise until it stops and remove it from the EF-EOS R Adaptor.

NOTE: Do not remove the EF-EOS R Adaptor from the camera.

2. Align the red dot on the EF-EOS R Adaptor mount cap (or the RED mount cap) with the red dot on the EF-EOS R Adaptor and insert the adaptor cap in the adaptor.
3. Turn the adaptor cap clockwise until it clicks in place.
4. Store the EF lens with the caps attached to both ends.

KOMODO OUTRIGGER HANDLE

The KOMODO Outrigger Handle offers a low profile, 360° adjustable ergonomic pistol grip and integrated Record Start/Stop button. Mounted to the Top Handle Port on your camera, the KOMODO Outrigger Handle provides comfort, stability, and additional 1/4-20 mounting points for your peripheral camera components. The built-in Record button puts Start/Stop functionality right at your fingertips. You are always ready to capture the perfect shot.



The KOMODO Outrigger Handle is ideal for shooters who use one hand on the handle, for grip and record button access, and the other for lens adjustments or support.

KOMODO EXPANDER MODULE

The KOMODO Expander Module provides extra hardware mounting points and connections for GPI, Genlock, Timecode, and CTRL (RS-232 control).



The KOMODO Expander Module connects to the camera through the **Extension Port**.

#	CONNECTOR	CONNECTOR TYPE	DETAILS
1	Module cable	9-pin 0B ODU	Attaches to the back of the Camera Body
2	GPI	BNC	Connection for remote trigger
3	Genlock	BNC	Connection for external Genlock device
4	Timecode	BNC	Connection for external Timecode device
5	CTRL	4-pin 00B ODU	CTRL (RS-232 Control) port for external RS-232 connection

LCD TOUCHSCREEN

This section describes the structure and layout of the graphical user interface (GUI) for the built-in camera touchscreen LCD. Advanced GUI menu controls enable convenient access to menus, camera features, and critical camera information.

NOTE: After 10 minutes of inactivity, the touchscreen will go to sleep. Tap the touchscreen or touch any button to wake the touchscreen. The touchscreen will not sleep while the camera is recording.



The LCD Touchscreen home page contains the following features:

STATUS BAR



The Status Bar contains the button for displaying the Home screen and Menu screen. It also contains status icons for various camera settings and inputs.

- ▶ **RED** Home/Menu toggle button
- ▶ **CF 0:46** Remaining CFast time icon
- ▶ **T/E** Temperature/Exposure (T/E) icon
- ▶ **TC** Timecode icon
- ▶ **GEN** Genlock icon
- ▶ **SYNC** SYNC icon
- ▶ **3D LUT** 3D LUT icon
- ▶ **Camera temperature icon**
- ▶ **LCD Touchscreen lock icon**
- ▶ **WiFi icon**
- ▶ **DC-In icon**
- ▶ **Battery usage and charge icon**

When you tap the Home/Menu toggle button (RED logo), the camera toggles the display between the menu page and the home page:



When you tap the Status bar icons the **Status Page** displays:

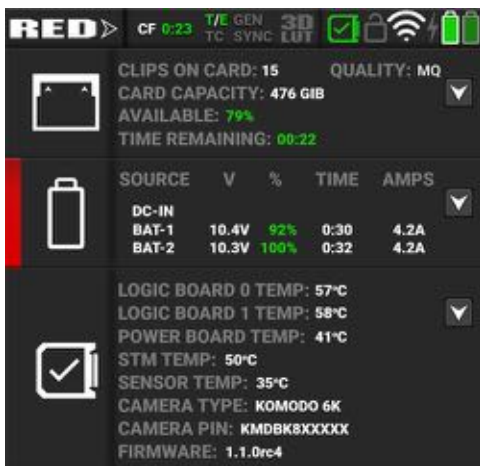

COLOR, AUDIO, AND MEDIA INFORMATION

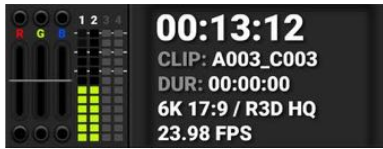

The Color, Audio, and Media section of the LCD home page displays the RGB exposure levels, the sound levels, the Timecode or Edgecode, clip ID, clip duration, resolution, format, and frame rate for the camera. Tap the Color/Audio meters to toggle between this display and the **Histogram** display.

HISTOGRAM

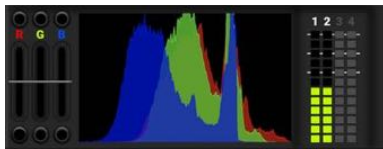

The Histogram section of the LCD home page displays the color exposure levels (with clipping indicators), image histogram, and audio VU meters. Tap this area to toggle between this display and the Color/Audio/Media display. For more information, refer to **Histogram**.

CAMERA DESIGNATION AND REC BUTTON



The Camera Designation and Record button on the LCD touchscreen home page displays the camera letter assigned to the camera (refer to **Slate** and **Camera ID**). You can tap this area to start and stop recording.

When the camera is recording, it changes the LCD appearance to this:



QUICK SETTINGS

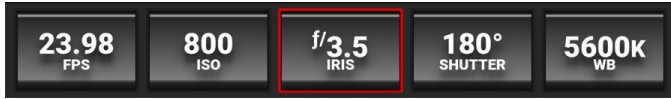

The Quick Settings section of the LCD home page displays the quick-access buttons for changing the most often used camera settings. These settings include **Recording Frame Rate**, **ISO**, **IRIS** (refer to **Lens**), **Shutter**, and **White Balance**.

Tap on a button to change the settings:



Swipe the setting left or right to make a selection. Click on the Quick Access button to close the selection screen.

BUTTON NAVIGATION

Pressing the Menu button next to the LCD touchscreen opens the main menu page. You can select the desired menu items by using the Up, Down, and Select (SEL) buttons. Pressing the Menu button also navigates backwards (**BACK**) from submenus in the menu tree.

Pressing the Up arrow and the Down arrow simultaneously locks/unlocks the touchscreen and the menu buttons. The Lock icon in the Status bar displays the lock status.

Pressing the Right button starts and stops playback (refer to [Playback](#) for more information).

Home Screen



Menu Screen



The menus include:

MENU	DETAILS
Image / LUT Menu	Frame Rates, ISO, Exposure, White Balance, Output Color Space, Output Tone Map, Highlight Roll-Off, Display Preset, CDL
Project Settings Menu	Format, Project Time Base, File Format, R3D Quality, ProRes Codec, Slate
Audio / TC Menu	Audio Source, Internal Audio, External Audio, Headphone Volume, Mute Headphone, Timecode Display Mode
Monitoring Menu	Top Port, SDI, Tools, Frame Guide, Video
Media Menu	Eject, Media Info, File System, Secure Format
Autofocus - BETA Menu	Enable and configure autofocus features ¹
Communication Menu	Camera name and WiFi settings
System Settings Menu	Camera hardware settings and status
Maintenance Menu	Calibration, Logs, Reset, and Firmware Update settings

1. The camera's autofocus feature requires lenses that support EF type autofocus.

STATUS PAGE

The Status page contains camera status information and shortcuts to the associated camera menus:



The camera status and menu shortcuts include:

ITEM	DETAILS
Media Menu	Displays the media status and a link to the Media menu
Power	Displays the power status and a link to the Power settings menu
System Status	Displays the camera temperature status and a link to the System Status menu
Project Settings Menu	Displays the project status and a link to the Project Settings menu
Lens	Displays the lens status and a link to the Lens settings menu
WiFi	Displays the communication status and a link to the WiFi settings menu
Audio / TC Menu	Displays the Audio / TC status and a link to the Audio / TC menu

HISTOGRAM

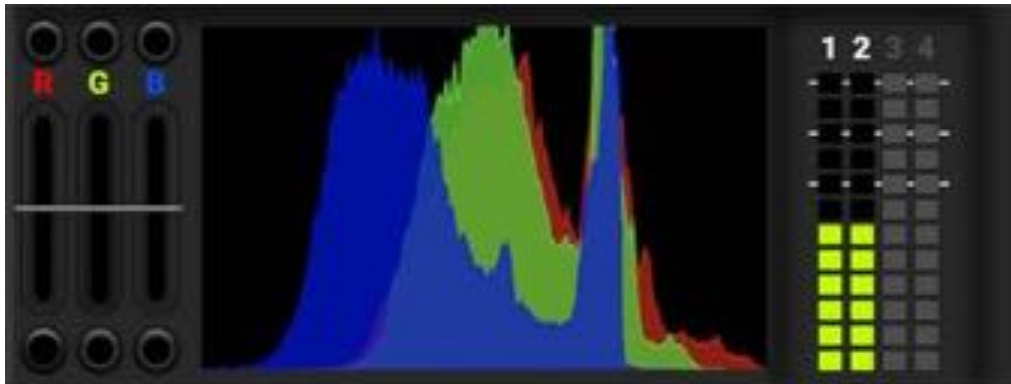

Tap this area to toggle between the Histogram display and the Color/Audio/Media display.



The Histogram section of the LCD home page displays the following:

- ▶ RGB Exposure
- ▶ Histogram
- ▶ Audio VU Meters

RGB EXPOSURE

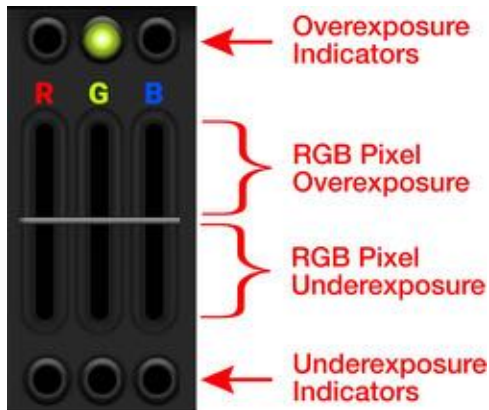

RGB Exposure displays the exposure levels of the separate RGB channels and indicates when a channel is underexposed or overexposed. This meter measures the raw image data regardless of the ISO and LUT settings.

Overexposed Example

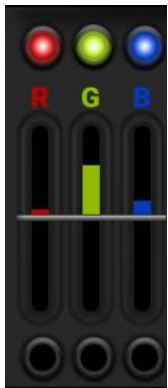

Underexposed Example

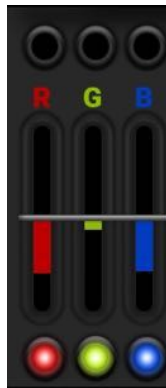

Balanced Example

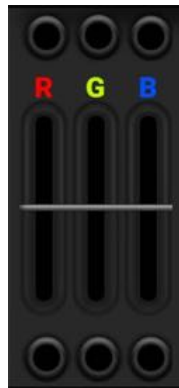

HISTOGRAM

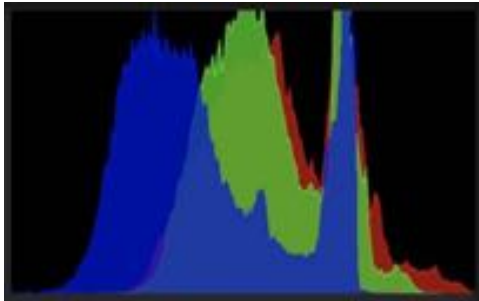

The histogram displays the darkest image elements at the far left, the midtones in the middle, and the lightest image elements at the far right. This gives you a fast way to determine your overall image exposure levels.

Overexposed Example

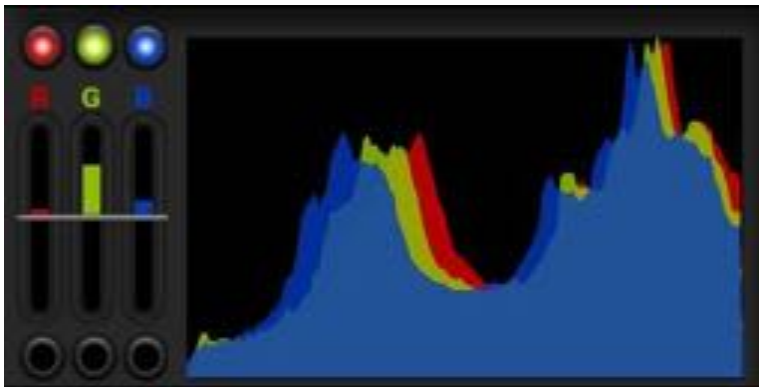

Underexposed Example

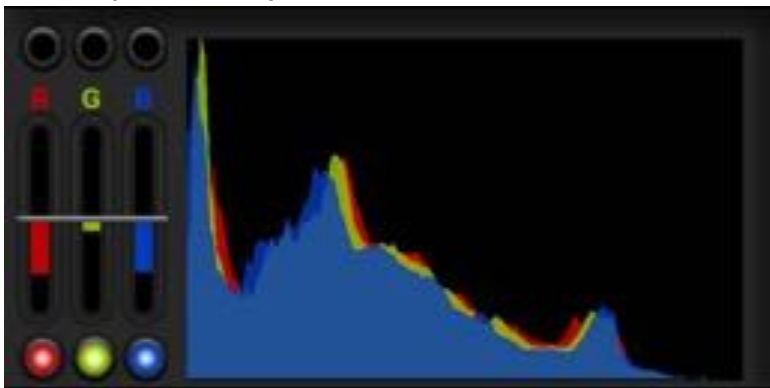

AUDIO VU METERS

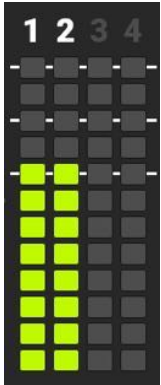

The Audio VU meters display the audio levels in the selected channels. Refer to the Audio / TC Menu section for more information about the audio channels.

Maximum VU Meter Example:

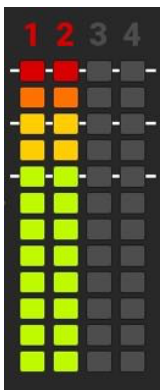

PLAYBACK

When you press on the Playback button, the LCD Touchscreen displays the Playback screen.



PLAYBACK SCREEN



The Playback screen displays the clip image along with the following:

- ▶ Clip Slider
- ▶ RGB Exposure
- ▶ Histogram
- ▶ Audio VU Meters
- ▶ Clip Information
- ▶ Playback Screen Buttons

CLIP SLIDER



Use your finger to move forward and backward through the frames by swiping the image to the left and the right. The Clip Slider shows where in the timeline the displayed frame is located in the clip.

RGB EXPOSURE

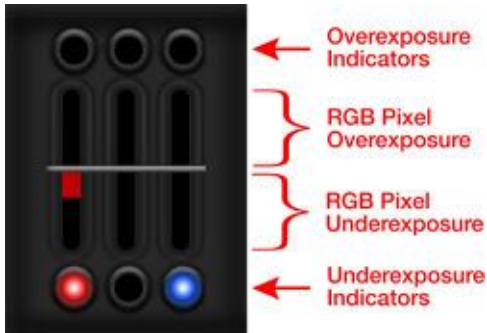

RGB Exposure displays the exposure levels of the separate RGB channels and indicates when a channel is underexposed or overexposed. This meter measures the raw image data regardless of the ISO and LUT settings.

HISTOGRAM

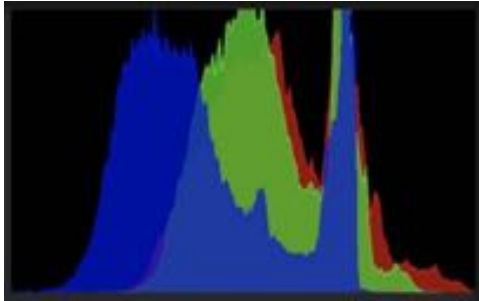

The histogram displays the darkest image elements at the far left, the midtones in the middle, and the lightest image elements at the far right. This gives you a quick way to view your overall image exposure levels.

AUDIO VU METERS



The Audio VU meters display the audio levels in the played clip.

CLIP INFORMATION

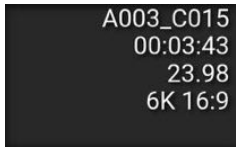

The Clip Information displays the timecode, elapsed time in the timeline, time base, and format of the clip.

PLAYBACK SCREEN BUTTONS

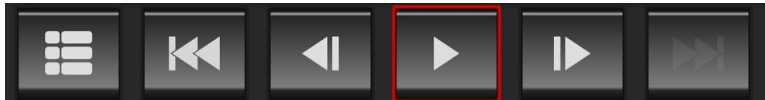

With the Playback screen buttons you can view the Clip list, move one clip back, move one frame back, play/pause, move one frame forward, and move one clip forward.

CLIP LIST

The Clip List button displays the list of clips recorded on the media card.

Each clip displays the first frame of the clip, the clip information, and the clip file format.



Swipe up and down to scroll through the list of clips. Tap the down arrow to open the clip information screen.



When you tap the load button, the camera loads the clip to the Playback screen.

4. MENUS

This section describes the menus and sub-menus for the camera. To access the menus, navigate to a menu item from the [LCD Touchscreen](#).

MENUS	DETAILS
Image / LUT Menu	Frame Rates, ISO, Exposure, White Balance, Output Color Space, Output Tone Map, Highlight Roll-Off, Display Preset, CDL
Project Settings Menu	Format, Project Time Base, File Format, R3D Quality, ProRes Codec, Slate
Audio / TC Menu	Audio Source, Internal Audio, External Audio, Headphone Volume, Mute Headphone, Timecode Display Mode
Monitoring Menu	Top Port, SDI, Tools, Frame Guide, Video
Media Menu	Eject, Media Info, File System, Secure Format
Autofocus - BETA Menu	Enable and configure autofocus features ¹
Communication Menu	Camera name and WiFi settings
System Settings Menu	Camera hardware settings and status
Maintenance Menu	Calibration, Logs, Reset, and Firmware Update settings

1. The camera's autofocus feature requires lenses that support EF type autofocus.

IMAGE / LUT MENU

The Image / LUT menu contains the settings you use to configure your image.

From the camera LCD touchscreen menu, select Image / LUT:

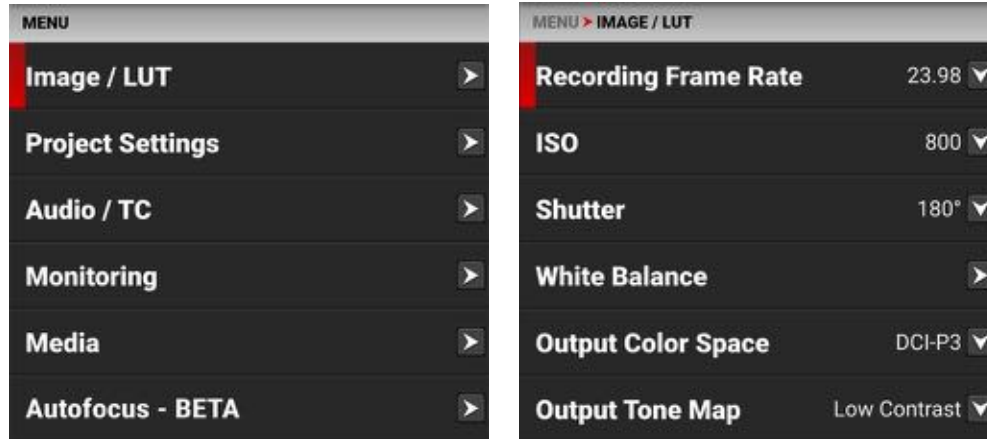

Use the Image / LUT menu to configure the camera's image and lookup table (LUT) settings:

ITEM	DETAILS
Recording Frame Rate	Adjusts the number of frames per second (FPS) that the camera records
ISO	Adjusts the sensitivity of the sensor to light
Shutter	Adjusts the amount of light exposed to the sensor
White Balance	Adjusts the colors to compensate for the light source temperature
Output Color Space	Adjusts on-set working color space
Output Tone Map	Adjusts the image contrast
Highlight Roll-Off	Adjusts image highlight compression
Display Preset	Adjusts on-set working gamma space
3D LUT	Manage the camera's look up tables (LUTs).
CDL	Opens the Color Decision List (CDL) menu

RECORDING FRAME RATE

Use Recording Frame Rate to select the recording frame rate (also referred to as the capture frame rate).

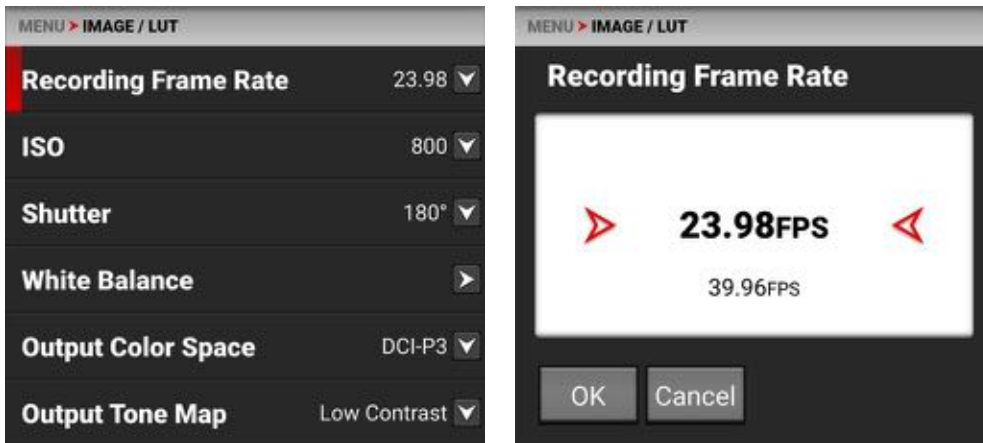

The recording frame rate is the number of frames per second (FPS) that are recorded. The recording frame rate is different from the project time base, which is the rate at which the footage will be played back.

The maximum frame rate for each format is determined by **Project Time Base** and **Format**.

NOTE: Frame rates highlighted in yellow will result in playback occurring at a different frame rate than the original recording, and will also not record audio.

RECORDING FRAME RATES FOR TIME BASE = 23.98 FPS

FORMAT					
6K 17:9	6K 2.4:1	6K 16:9	5K 17:9	4K 17:9	2K 17:9
23.98 FPS	23.98 FPS	23.98 FPS	23.98 FPS	23.98 FPS	23.98 FPS
39.96 FPS	47.95 FPS	39.96 FPS	47.95 FPS	47.95 FPS	47.95 FPS
	49.95 FPS			59.94 FPS	71.93 FPS
					95.09 FPS
					119.88 FPS

RECORDING FRAME RATES FOR TIME BASE = 24 FPS

FORMAT					
6K 17:9	6K 2.4:1	6K 16:9	5K 17:9	4K 17:9	2K 17:9
24 FPS	24 FPS	24 FPS	24 FPS	24 FPS	24 FPS
40 FPS	48 FPS	40 FPS	48 FPS	48 FPS	48 FPS
	50 FPS			60 FPS	72 FPS
					96 FPS
					120 FPS

RECORDING FRAME RATES FOR TIME BASE = 25 FPS

FORMAT

6K 17:9	6K 2.4:1	6K 16:9	5K 17:9	4K 17:9	2K 17:9
25 FPS	25 FPS	25 FPS	25 FPS	25 FPS	25 FPS
40 FPS	50 FPS	40 FPS	48 FPS	50 FPS	50 FPS
				60 FPS	75 FPS
					100 FPS
					120 FPS

RECORDING FRAME RATES FOR TIME BASE = 29.97 FPS

FORMAT

6K 17:9	6K 2.4:1	6K 16:9	5K 17:9	4K 17:9	2K 17:9
29.97 FPS	29.97 FPS	29.97 FPS	29.97 FPS	29.97 FPS	29.97 FPS
39.96 FPS	49.95 FPS	39.96 FPS	47.95 FPS	59.94 FPS	59.94 FPS
					89.91 FPS
					119.88 FPS

RECORDING FRAME RATES FOR TIME BASE = 30 FPS

FORMAT

6K 17:9	6K 2.4:1	6K 16:9	5K 17:9	4K 17:9	2K 17:9
30 FPS	30 FPS	30 FPS	30 FPS	30 FPS	30 FPS
40 FPS	50 FPS	40 FPS	48 FPS	60 FPS	60 FPS
					90 FPS
					120 FPS

RECORDING FRAME RATES FOR TIME BASE = 50 FPS

FORMAT

6K 17:9	6K 2.4:1	6K 16:9	5K 17:9	4K 17:9	2K 17:9
40 FPS	50 FPS	40 FPS	48 FPS	50 FPS	50 FPS
				60 FPS	100 FPS

RECORDING FRAME RATES FOR TIME BASE = 59.94 FPS

FORMAT					
6K 17:9	6K 2.4:1	6K 16:9	5K 17:9	4K 17:9	2K 17:9
39.96 FPS	49.95 FPS	39.96 FPS	47.95 FPS	59.94 FPS	59.94 FPS
					119.88 FPS

RECORDING FRAME RATES FOR TIME BASE = 60 FPS

FORMAT					
6K 17:9	6K 2.4:1	6K 16:9	5K 17:9	4K 17:9	2K 17:9
40 FPS	50 FPS	40 FPS	48 FPS	60 FPS	60 FPS
					120 FPS

ISO

Use the ISO setting to increase or decrease the camera's sensitivity to light.

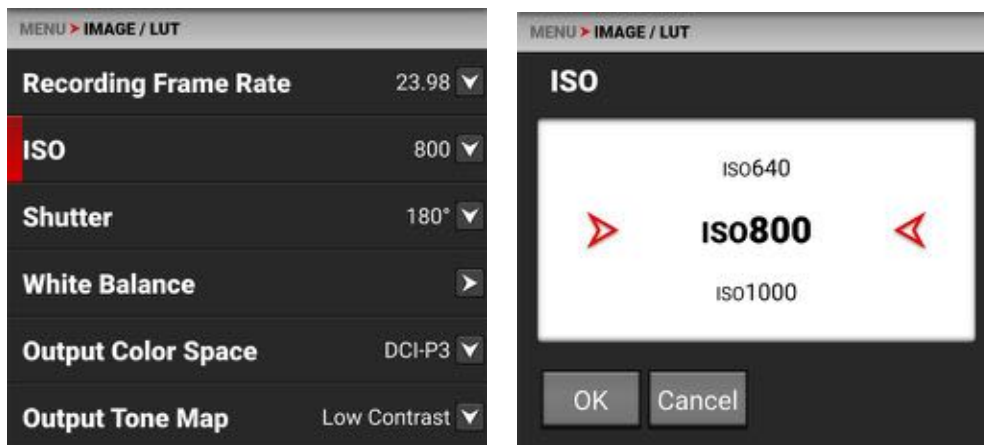

The ISO Range is ISO 250 to ISO 12,800. The default ISO is ISO 800.

Higher ISO values create brighter images in the monitor path, and lower ISO values create darker images in the monitor path.

When you record using the R3D **File Format**, the ISO settings are stored as metadata and you can adjust them later in post-processing with REDCINE-X PRO or other editing tools that support R3D files.

RED recommends setting the ISO to the default, then adjusting the aperture, lighting, and ND filters to match. The ISO can later be adjusted for fine-tuning.

SHUTTER

Use Shutter to select the amount of light exposed to the sensor (shutter speed / shutter angle). You can change the shutter settings while recording.

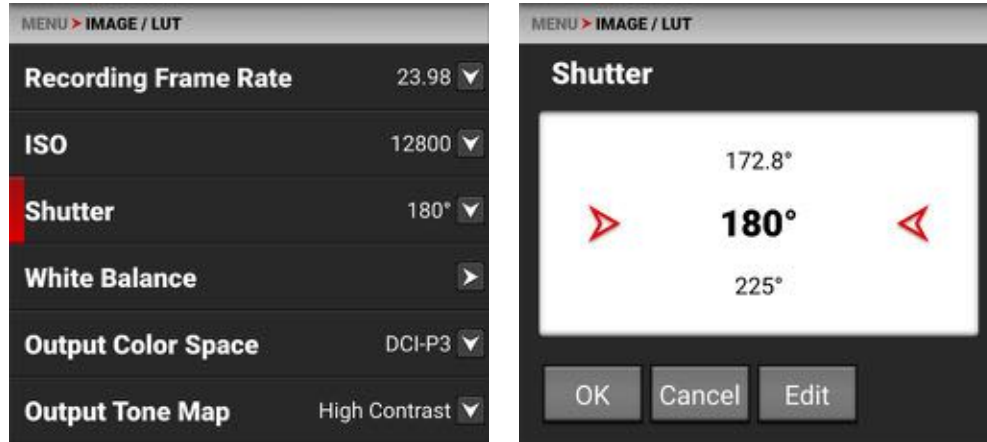

You can switch between angle and time by using the [Status Settings](#).

Decreasing shutter speed increases the amount of time that light hits the sensor, which increases exposure and motion blur of moving objects. Increasing shutter speed decreases the amount of time that light hits the sensor, which decreases exposure and motion blur of moving objects.

SHUTTER ANGLE

Enter the exposure value as a shutter angle (xx°). The shutter angle range is 0° to 360°. The default shutter angle is 180°.

EXPOSURE CONVERSIONS

The table below lists common shutter angle and shutter speed equivalents. The calculations in the table use a recording frame rate of 23.98 fps.

SHUTTER ANGLE (°)	SHUTTER SPEED (1/XX SEC)	SHUTTER ANGLE (°)	SHUTTER SPEED (1/XX SEC)
360°	1/23.98	105°	1/82.20
288°	1/29.97	90°	1/95.90
270°	1/31.97	72°	1/119.88
240°	1/35.96	45°	1/191.81
225°	1/38.36	22.5°	1/383.62
180°	1/47.95	11.2°	1/770.66
172.8°	1/49.95	8.6°	1/1003.65
144°	1/59.94	4°	1/2157.84
135°	1/63.95	1°	1/8000 (max)
120°	1/71.93		

INTEGRATION TIME

Enter the exposure value as a shutter speed (1/xx sec).

The slowest shutter speed is 1/(recording frame rate). For example, if the recording frame rate is 23.98 fps, the slowest available shutter speed is 1/23.98 sec. The fastest shutter speed is 1/8000 sec. The default shutter speed is 1/47.95 sec.

CONVERT SHUTTER SPEED TO SHUTTER ANGLE

Shutter Angle = (Shutter Speed x Frame Rate x 360)

Example: (1/47.95 x 23.98 x 360) = 180

CONVERT SHUTTER ANGLE TO SHUTTER SPEED

Shutter Speed = 1/(Frame Rate x 360/Angle)

Example: 1/(23.98 x 360/180) = 1/47.95

WHITE BALANCE

Use the White Balance menu to adjust the **Color Temperature** and the **Tint**.

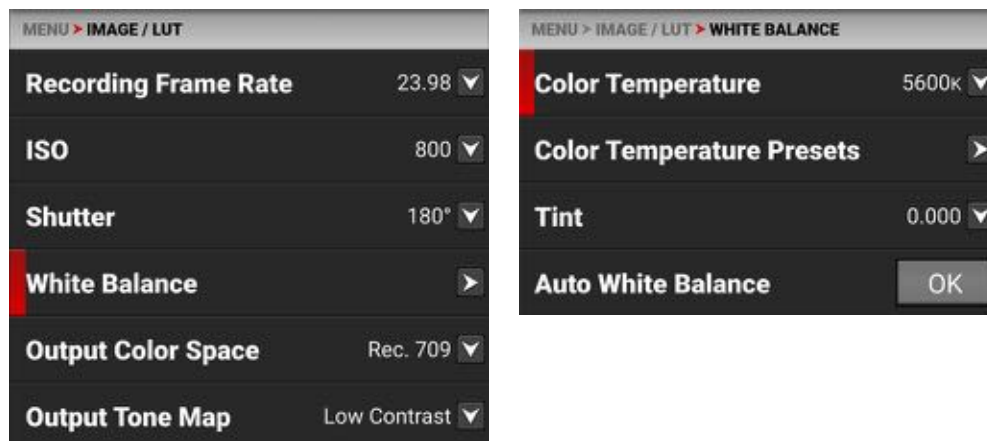

Use the White Balance menu to configure the color temperature and tint settings for your image:

ITEMS	DETAILS
Color Temperature	Image color temperature correction
Color Temperature Presets	Tap a button to select a preset color temperature
Tint	Adjust magenta-green color component
Auto White Balance	The camera automatically sets the color temperature and tint

COLOR TEMPERATURE

Use Color Temperature to adjust the image's color temperature in Kelvin units (K).

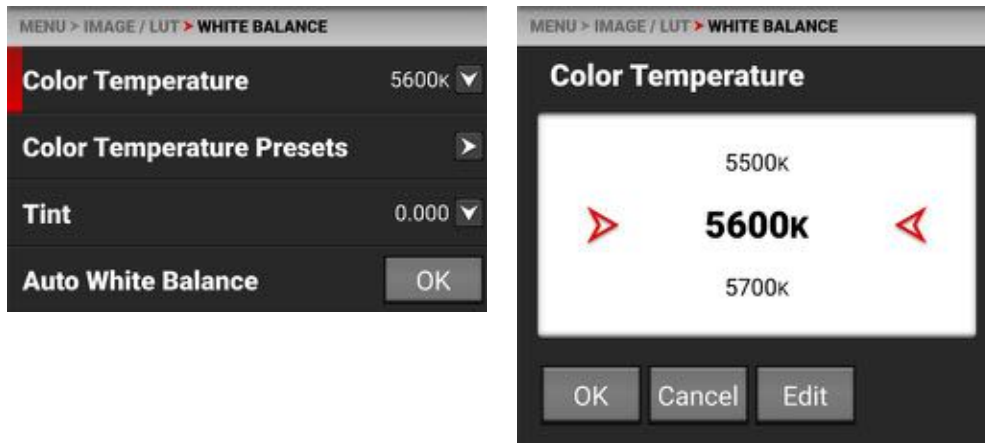

When the image's light source color temperature is warm, you can compensate by setting the camera to a warmer color temperature. When the image's light source color temperature is cool, you can compensate by setting the camera to a cooler temperature.

The color temperature range is 1,700 K to 10,000 K.

The camera's default color temperature is 5600 K.

COLOR TEMPERATURE PRESETS

Use Color Temperature Presets to select a pre-configured color temperature.

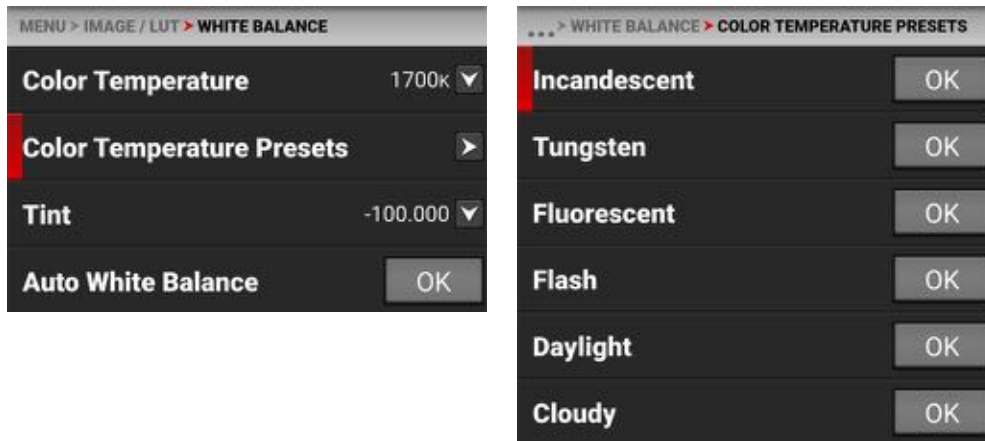

The color temperature presets you can select include:

ITEMS	DETAILS	ITEMS	DETAILS
Incandescent	2800 K	Daylight	5600 K
Tungsten	3200 K	Cloudy	7000 K
Fluorescent	4500 K	Shade	8000 K
Flash	5500 K		

TINT

Use Tint to adjust the image color tint.

Color temperature calculations assume a pure light source that may not be true in the specific scene the camera is imaging. To compensate for any residual colorcast, the Tint setting adjusts the RGB color balance with a compensating magenta-green color component.

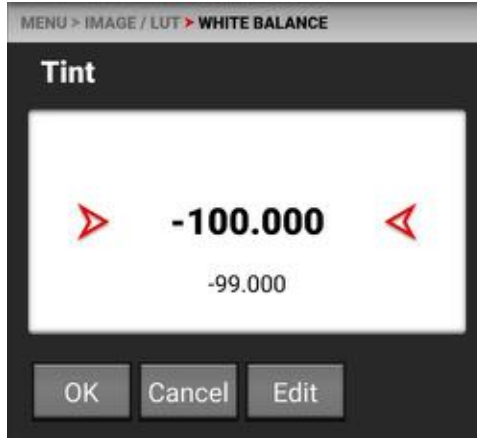
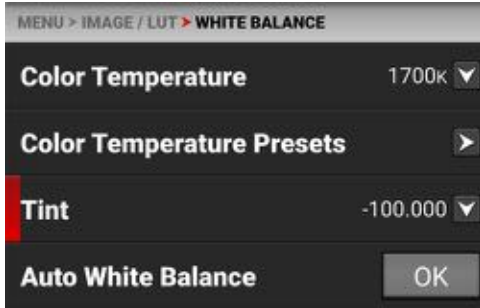

Tint range is -100.000 to 100.000. The default Tint setting is 0.000.

Use Edit to open the keypad screen where you can enter a specific Tint value.

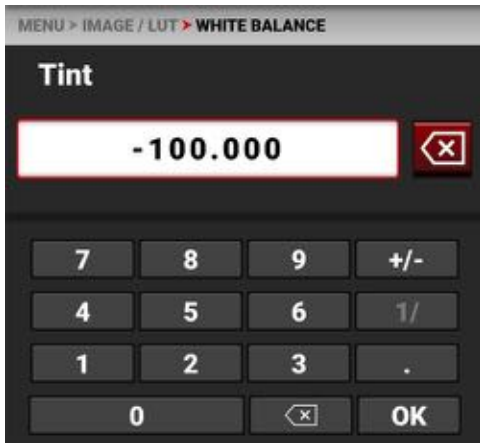

AUTO WHITE BALANCE

Use Auto White Balance to use the camera's automatic white balance adjustment.

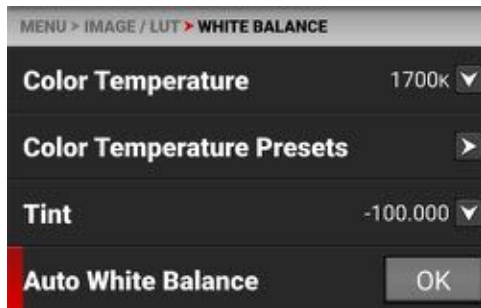

To use Auto White Balance:

1. Place an 18% gray chart in the center of the image under the correct exposure.
2. From the **White Balance** menu tap OK next to **Auto White Balance**.
3. The camera automatically sets the color temperature and tint settings.

OUTPUT COLOR SPACE

Use Output Color Space to select the desired Color Space to use when displaying the camera output.

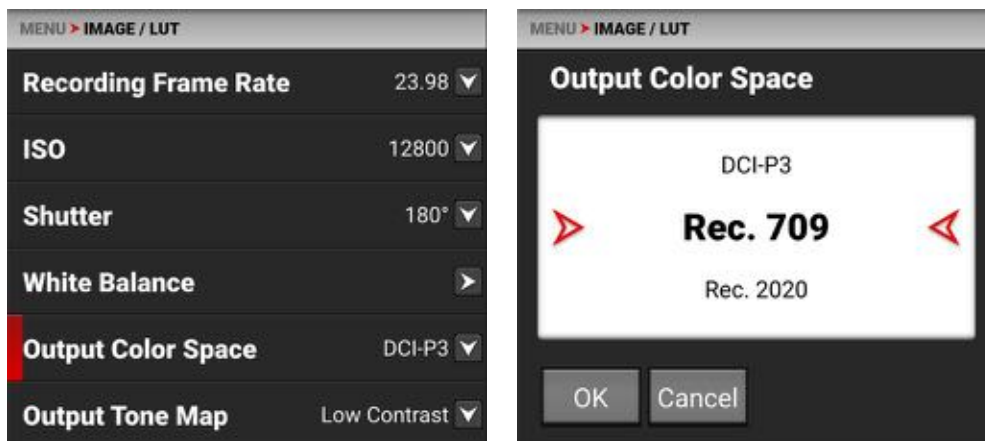

The Output Color Space selections include:

- ▶ DCI-P3 - Digital Cinema Initiatives theater projector standard color space
- ▶ Rec. 709 - Standard Color Space for HDTV (default)
- ▶ Rec. 2020 - Standard Color Space for UHD and HDR
- ▶ RED Wide Gamut RGB - Color space encompassing all of the colors the RED camera can generate without clipping.

OUTPUT TONE MAP

Use Output Tone Map to adjust the image contrast when displaying the camera output.

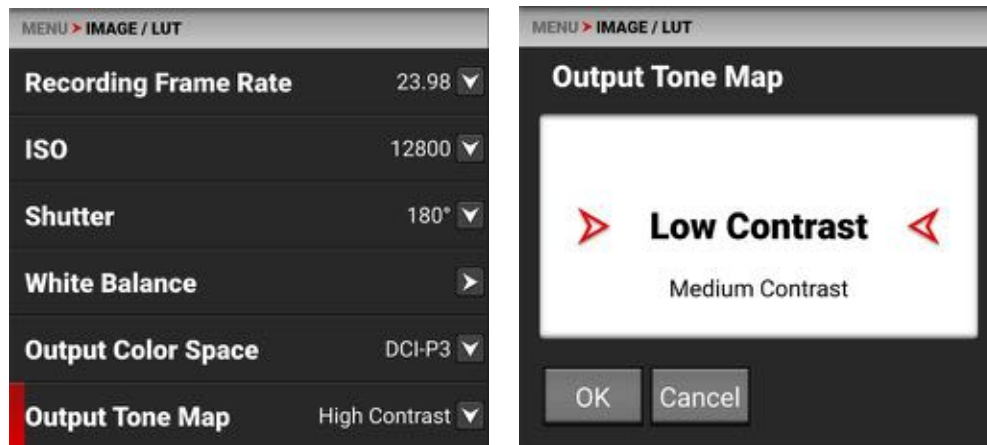

The Output Tone Map selections include:

- ▶ Low Contrast - Low contrast is applied to the image (default)
- ▶ Medium Contrast - Medium contrast is applied to the image
- ▶ High Contrast - High contrast is applied to the image
- ▶ None - No contrast is applied to the image

HIGHLIGHT ROLL-OFF

Use Highlight Roll-Off to select the desired highlight compression to use when displaying the camera output.

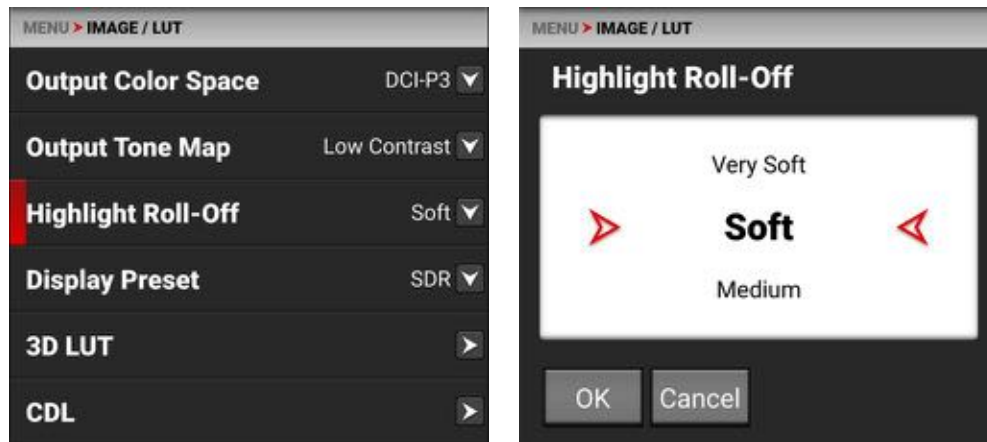

The Highlight Roll-Off selections include:

- ▶ Very Soft - The lightest compression is applied to the image highlights
- ▶ Soft - Soft compression is applied to the image highlights (default)
- ▶ Medium - Medium compression is applied to the image highlights
- ▶ Hard - The highest compression is applied to the image highlights
- ▶ None - No compression is applied to the image highlights

DISPLAY PRESET

Use Display Preset to select the gamma of the displayed image:

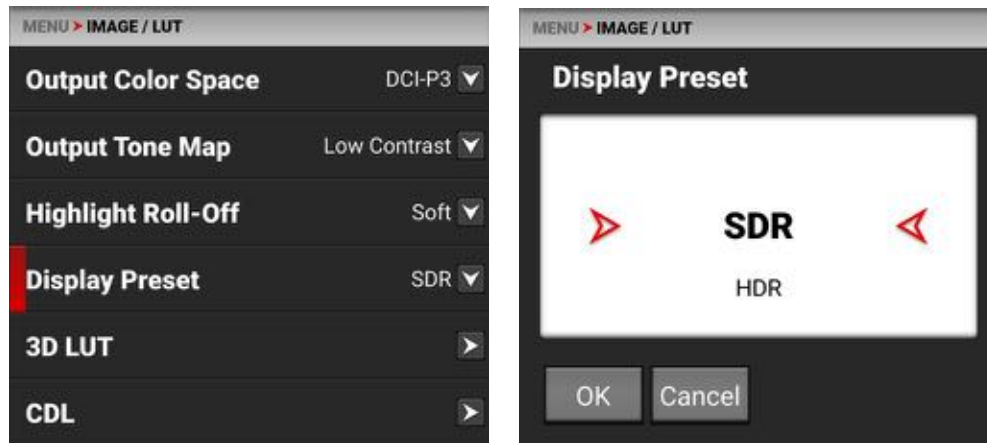

The Display Preset allows you to select the gamma for the camera recording.

The selections are:

- ▶ SDR - **Standard Dynamic Range (SDR)** (default)
- ▶ HDR - **High Dynamic Range**
- ▶ HLG - **Hybrid Log-Gamma (HLG)**

STANDARD DYNAMIC RANGE (SDR)

Standard-dynamic-range (SDR) video describes images or video using a conventional gamma curve signal. The conventional gamma curve is based on the limits of the cathode ray tube which allowed for a maximum luminance of 100 candelas per square meter (cd/m²).

HIGH DYNAMIC RANGE

High Dynamic Range (HDR) images are recorded using technology that captures and outputs a greater range of luminance than images recorded using Standard Dynamic Range (SDR) methods.

HYBRID LOG-GAMMA (HLG)

Hybrid Log-Gamma (HLG) delivers HDR resolution without the need for metadata. This allows HLG to display well on SDR and HDR monitors.

BACKGROUND

NHK and the BBC developed HLG in a joint effort to create a more compatible signal for a wide variety of television sets.

Hybrid Log-Gamma is an open-source standard HDR (High Dynamic Range) video format. Video dynamic range is the measurement between the brightness between black and white (luminosity).

Many monitors offer HDR. However, unlike resolution parameters (1080p, 4K, etc.), HDR is related to luminosity. Luminosity can vary between how an image is captured on a camera and how the image is broadcast to a monitor.

HDR, using Perceptual Quantizer (PQ), sends a signal along with metadata. This metadata is read by the monitor which then displays the signal using the luminosity information supplied by the metadata.

HLG sends a combination (hybrid) of the normal Gamma curve for light coding and a logarithmic curve to deliver the HDR aspects of the signal.

3D LUT

Use the 3D LUT menu to apply and manage the camera's Look-Up Tables (LUTs).

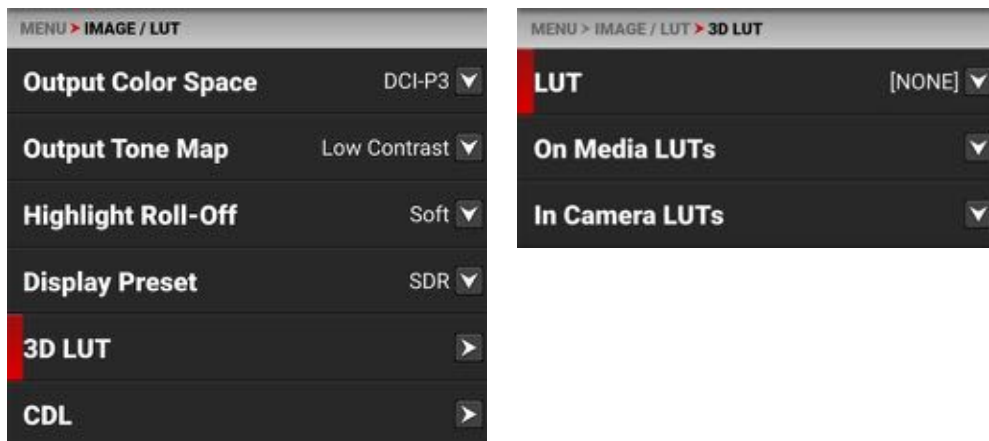

SELECT LUT



If you are recording to a ProRes codec you can choose to irreversibly encode (bake) the 3D LUT into the recorded file. For more information, refer to the [ProRes Baked-In Settings](#) section.

To apply a 3D LUT, follow the instructions below:

1. Go to **MENU > IMAGE / LUT > 3D LUT > LUT**.
2. Select a LUT from the **LUT** list.

ON MEDIA LUTS

To import 3D LUTs from media, go to **MENU > IMAGE / LUT > 3D LUT > On Media LUTs**.

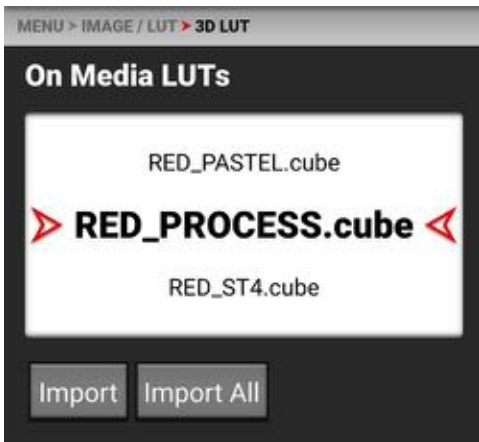

3D LUTs can be imported from media to the camera. When importing 3D LUTs from media to the camera, the 3D LUTs must be saved on the root path of your media, in a folder titled "luts".

From On Media LUTs you can:

- ▶ Import the selected 3D LUT from the media to the camera
- ▶ Import all 3D LUTs from the media to the camera.

IN CAMERA LUTS

To export and delete 3D LUTs stored in the camera, go to **MENU > IMAGE / LUT > 3D LUT > In Camera LUTs**.



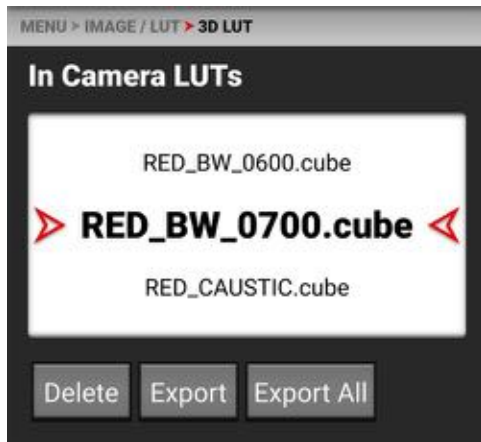

You can export 3D LUTs stored on the camera, to media, to use on other cameras. When you export 3D LUTs from the camera to media, the 3D LUTs are saved to a folder on the media called “luts”.

From In Camera LUTs you can:

- ▶ Delete a selected 3D LUT from the camera
- ▶ Export a selected 3D LUT from the camera to the media
- ▶ Export all 3D LUTs from the camera to the media.

CDL

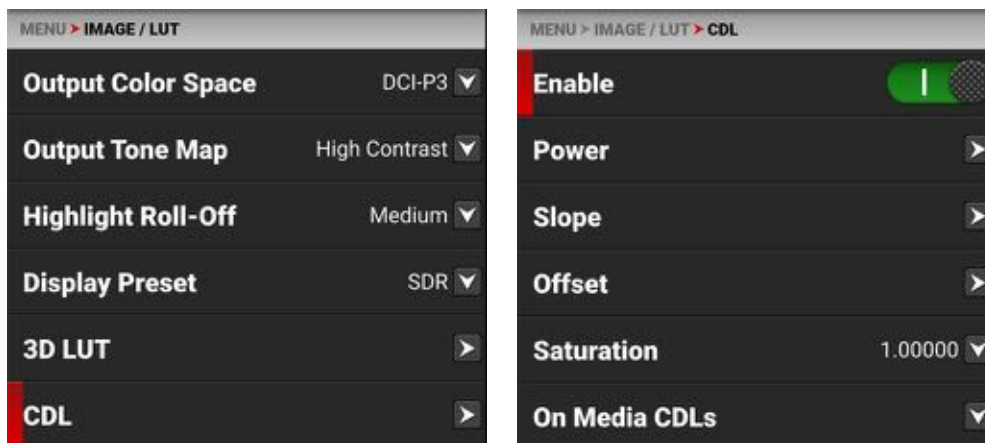

The Color Decision List (CDL) allows you define the look of the camera's colors in your project.

Use the CDL menu to:

- ▶ Enable the CDLs
- ▶ Configure **CDL Power**
- ▶ Configure **CDL Slope**
- ▶ Configure **CDL Offset**
- ▶ Configure **CDL Saturation**

MANAGE CDLS

Use the CDLs menu to import and export CDLs.

CDLs can be stored on the camera or transferred to media to be shared with other cameras. When exporting CDLs from camera to media, the CDLs are saved to a folder on the media called “cdls”. When importing CDLs from media to the camera, the CDLs must be stored on the media in a folder called “cdls”.

To export selected CDLs from the camera to the media, refer to the [In Camera CDLs](#) section.

To import selected CDLs from the media to the camera, refer to the [On Media CDL](#) section.

CDL OVERVIEW

A Color Decision List (CDL) is a metadata file format developed by the The American Society of Cinematographers (ASC) to exchange standard color correction information between post production tools. This non-destructive color adjustment layer simplifies the versioning of looks by updating simple metadata without the need to re-transfer the image data.

CDLs are very common in VFX workflows because the VFX artist needs both the ungraded shot and the intended look. The ungraded shot allows the artist to comp in truly linear light, and the intended look is needed to confirm that the individual plates still hold together after the grade is applied.

SLOPE, OFFSET AND POWER

The three CDL tone curve parameters are Slope, Offset and Power. These algorithms allow the camera to modify the recorded image.

- ▶ Slope multiplies the incoming data
- ▶ Offset is sum of the incoming data
- ▶ Power is a power function to the incoming data

These three relate to Gain, Lift, and Gamma in the following ways:

- ▶ Slope = Gain
Gain Adjusts highlights.
- ▶ Offset = Lift
Lift Increases the value of dark colors.
- ▶ Power = Gamma
Gamma adjusts midtones.

These three relate to each other in the following ways:

Slope= input x slope

Offset= (input x slope) + offset

Power= ((input x slope) + offset) ^ power

The formula for ASC CDL color correction is:

$$out = ((i \times s) + o)^p$$

where

out is the color graded pixel code value

i is the input pixel code value (0=black, 1=white)

s is slope (any number 0 or greater, nominal value is 1.0)

o is offset (any number, nominal value is 0)

p is power (any number greater than 0, nominal value is 1.0)

The formula is applied to the three color values for each pixel using the corresponding slope, offset, and power numbers for each color channel.

SATURATION

A fourth parameter “Saturation” is achieved by converting the *out* data in a Luma and Chroma component. The Chroma Signal is then multiplied by the “Saturation” parameter.

FILM GRADE AND VIDEO GRADE

With Slope and Offset you can produce both a Film Grade “Exposure” and “Contrast” and a Video Grade “Lift” and “Gain”.

- ▶ Exposure is achieved by Offset
- ▶ Contrast is achieved by a combination of Offset and Slope
- ▶ Gain is achieved by Slope
- ▶ Lift is achieved by a combination of Offset and Slope
- ▶ Gamma is achieved by Power

CDL POWER

The CDL defines the image settings for the red, green, and blue channel. The three CDL tone curve parameters are Slope, Offset and Power. These algorithms allow the camera to modify the recorded image. The CDL Power settings control the power of the Red, Green, Blue, color data.

The Camera LCD Menu for CDL Power:

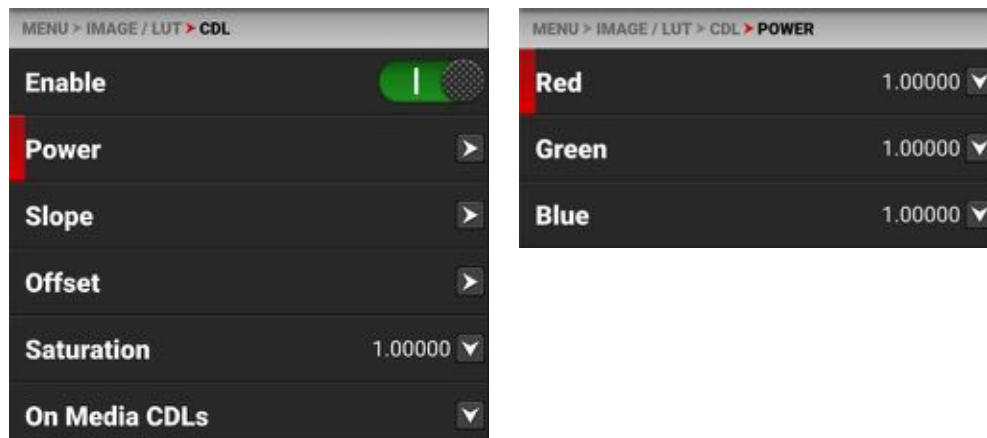

Use the CDL Power menu to adjust the power of the Red, Green, and Blue CDL data.

CDL POWER SETTINGS

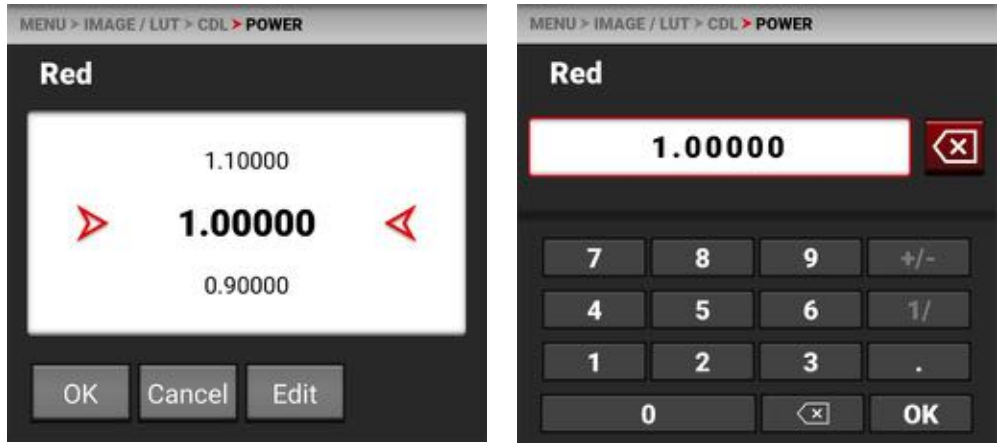

The CDL Power settings range from 0.00000 to 4.00000. The default CDL Power setting for each color is 1.00000. The Edit button opens the keypad where you can enter a specific CDL Power value.

CDL SLOPE

The CDL defines the image settings for the red, green, and blue channel. The three CDL tone curve parameters are Slope, Offset and Power. These algorithms allow the camera to modify the recorded image. The CDL Slope settings multiply the incoming RGB data.

The Camera LCD Menu for CDL Slope:

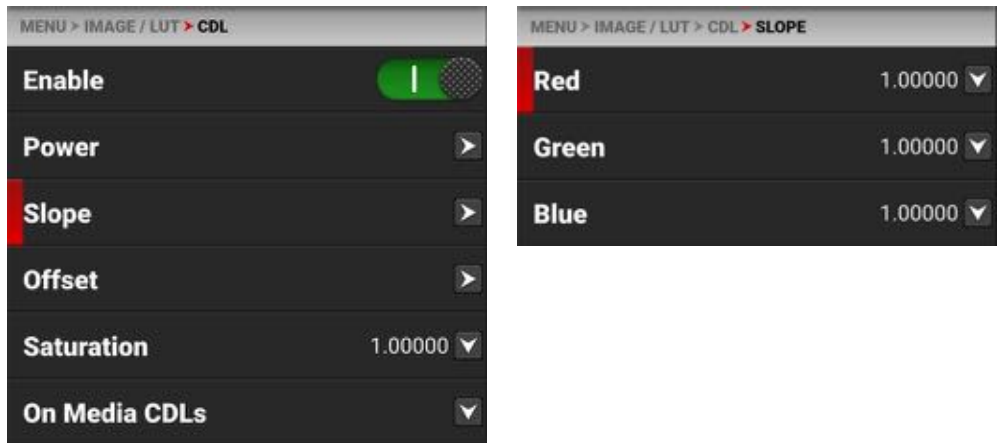

Use the CDL Slope menu to set the slope of the red, green, and blue signals.

SLOPE SETTINGS

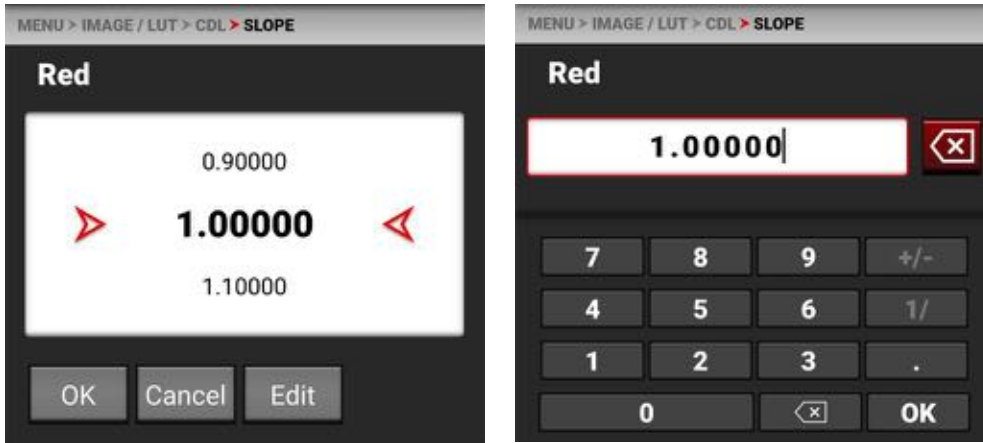

The CDL Slope settings range from 0.00000 to 2.00000. The default CDL Slope settings are 1.00000. The Edit button opens a keypad where you can enter a specific CDL Slope value.

CDL OFFSET

The CDL defines the image settings for the red, green, and blue channel. The three CDL tone curve parameters are Slope, Offset and Power. These algorithms allow the camera to modify the recorded image. The CDL Offset settings control the offset of the RGB color data.

The Camera LCD Menu for CDL Offset:

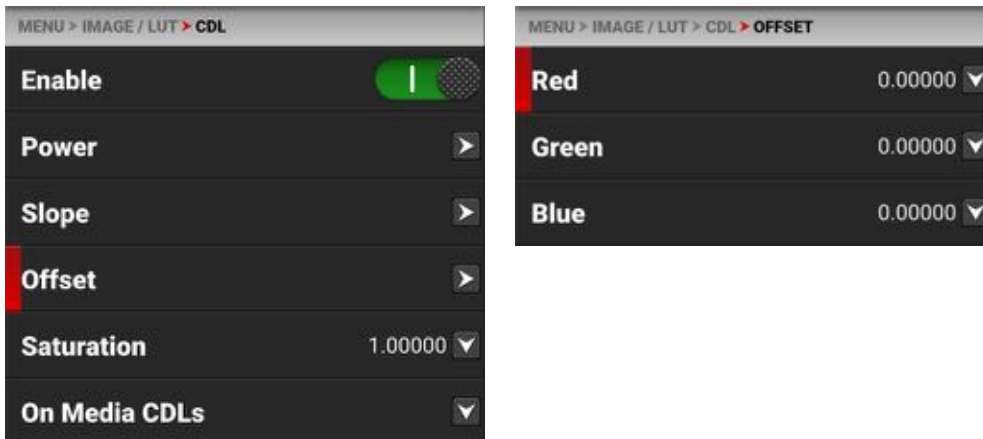

Use the CDL Offset menu to adjust the offset of the **CDL Slope** for the Red, Green, and Blue CDL data.

RED GREEN AND BLUE OFFSETS

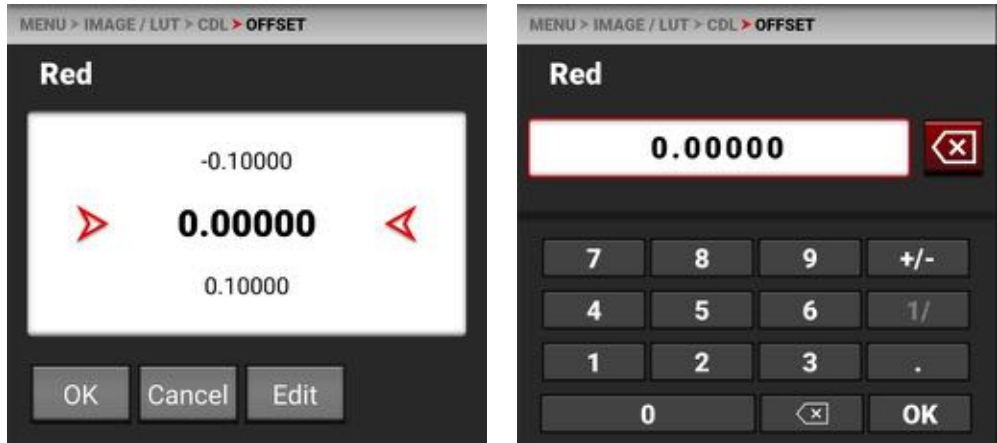

These CDL Offset settings range from -1.00000 to 1.00000. The default CDL Offset setting for each is 0.00000. The Edit button opens the keypad, where you can enter a specific CDL Offset value.

CDL SATURATION

The CDL defines the image settings for the red, green, and blue channel. The three CDL tone curve parameters are Slope, Offset and Power. These algorithms allow the camera to modify the recorded image. The CDL Saturation settings control the intensity of the color data.

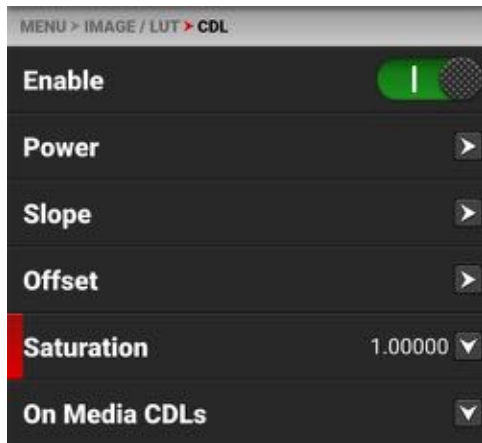

Use the CDL Saturation menu to adjust the intensity of the image color.

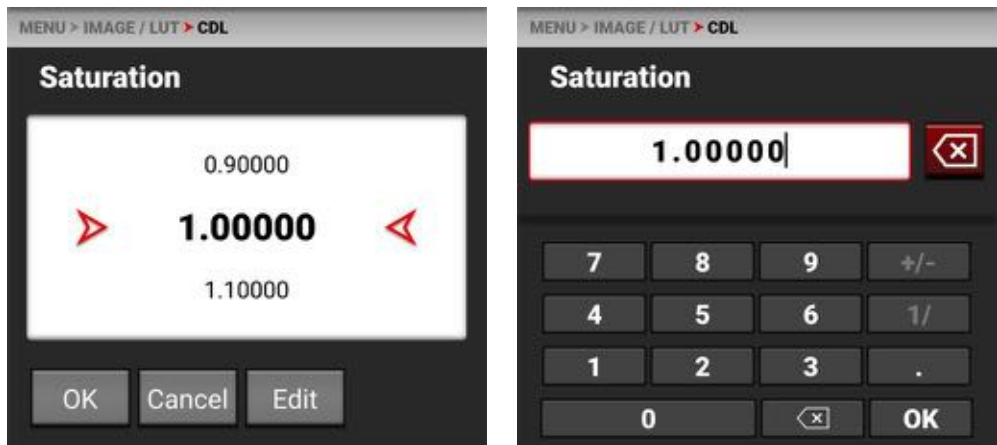

The CDL Saturation settings range from 0.00000 to 4.00000. The default CDL Saturation setting is 1.00000. The Edit button opens a keypad where you can enter a specific CDL Saturation value.

ON MEDIA CDL

Use On Media CDLs to copy CDLs stored on the media and store them on the camera.

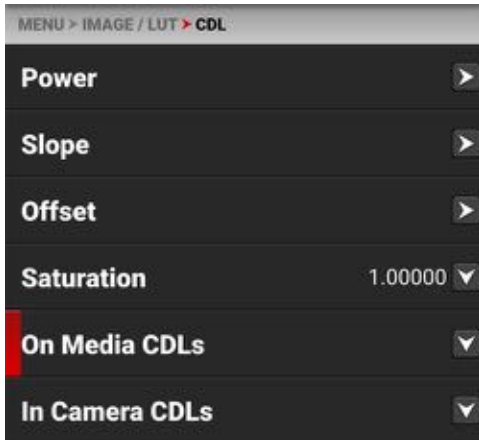

CDLs can be imported from media to the camera. When importing CDLs from media to the camera, the CDLs are saved to a folder on the camera called “cdls”.

From On Media CDLs you can import the selected CDL from the media to the camera or import all of the CDLs from the media to the camera.

IN CAMERA CDLS

Use In Camera CDLs to copy CDLs stored on the camera and store them on the media. You can also select which stored CDLs you want the camera to use.

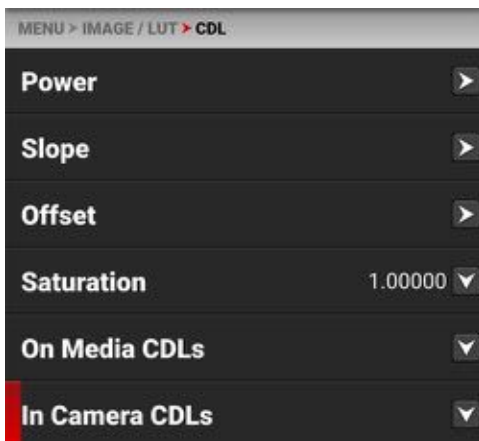

CDLs can be exported from the camera to the media. When exporting CDLs from camera to the media, the CDLs are saved to a folder on the media called “cdls.”

From In Camera CDLs you can apply the selected CDL to the camera, delete the selected CDL from the camera, export the selected CDL from the camera to the media, or export all of the CDLs from the camera to the media

PROJECT SETTINGS MENU

The Project Settings menu contains the settings you use to enter your cinematography project information.

From the camera LCD touchscreen menu, tap Project Settings:

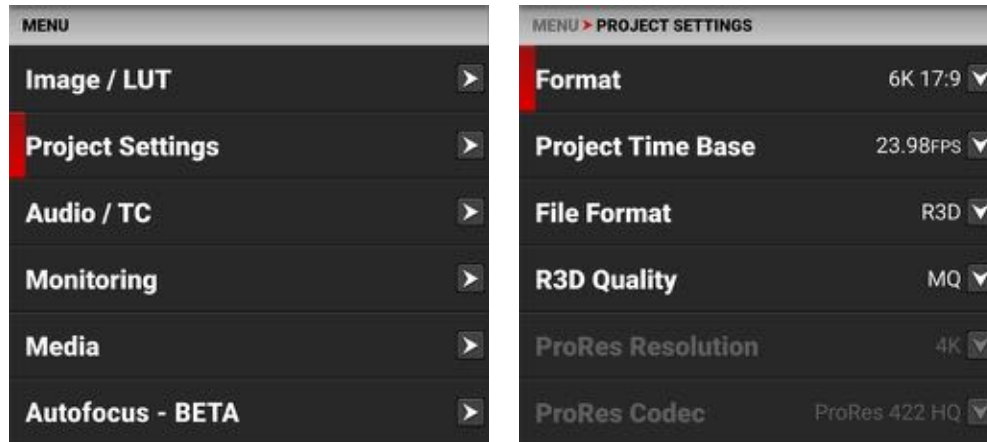

Use the Project Settings menu to configure the settings for your cinematography project:

ITEMS	DETAILS
Format	Size of the area captured by the sensor
Project Time Base	Image playback rate
File Format	R3D or ProRes file formats
R3D Quality	Data rate of the recorded image file
ProRes Resolution	ProRes SDI recording data rate
ProRes Codec	ProRes codec selection
ProRes Baked-In Settings	Bake in RWG/Log3G10 or 3D LUT settings
Slate	Camera ID and camera position

FORMAT

Use the Format setting to designate how much of the sensor the camera should use to capture images.

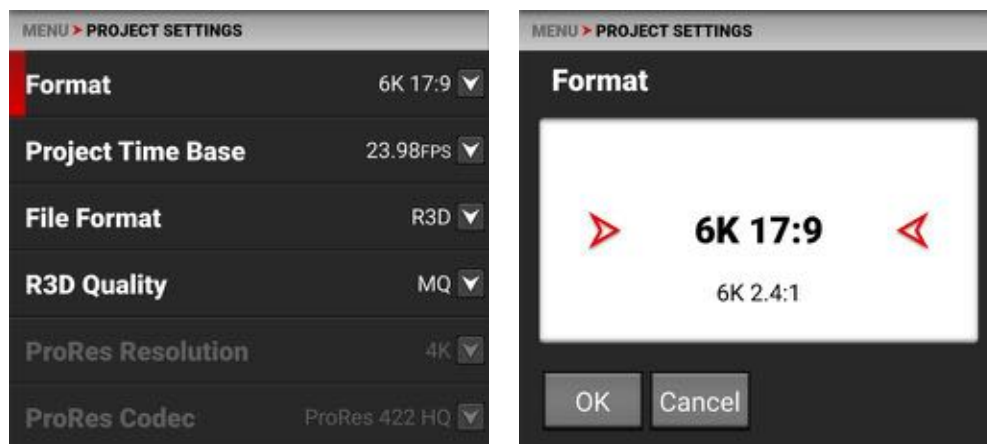

The table below describes the formats for the camera. The table omits rows for the anamorphic formats, since the pixel dimensions for each anamorphic format and the corresponding non-anamorphic format are the same.

The available aspect ratios are determined by the selected resolution.

When you lower the resolution on the camera, only a portion of the sensor is used. The camera does not downscale from 17:9 format when recording RAW.

FORMAT SPECIFICATIONS

This table contains the dimensions of the sensor area in Pixels and in Millimeters used by each format.

FORMAT	DIMENSION (PIXELS)		DIMENSIONS (MM)		
	WIDTH	HEIGHT	WIDTH	HEIGHT	DIAGONAL
6K 17:9	6144	3240	30.7	16.2	34.7
6K 2.4:1	6144	2592	30.7	13.0	33.0
6K 16:9	5760	3240	28.8	16.2	33.0
5K 17:9	5120	2700	25.6	13.5	29.0
4K 17:9	4096	2160	20.5	10.8	23.2
2K 17:9	2048	1080	10.2	5.4	11.6

PROJECT TIME BASE

Use the Project Time Base setting to choose the playback rate for the recorded footage.

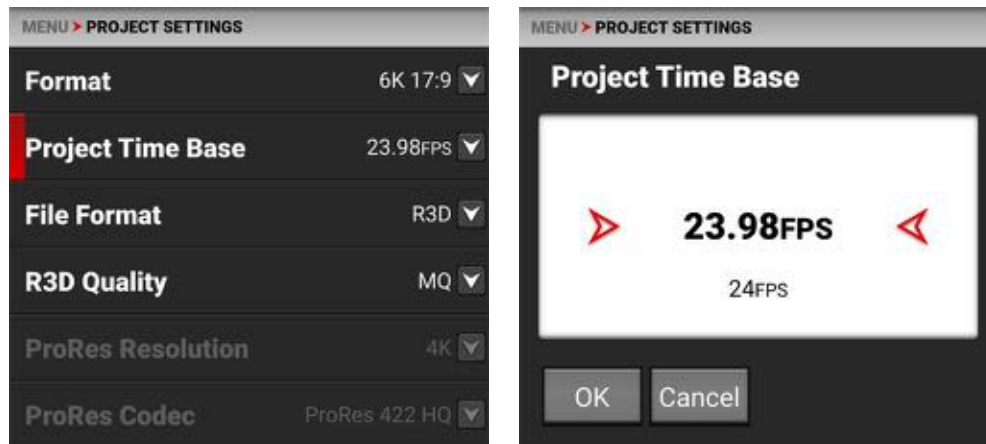

The following project time bases are available:

- ▶ 23.98 FPS (Default)
- ▶ 24.00 FPS
- ▶ 25.00 FPS
- ▶ 29.97 FPS
- ▶ 30.00 FPS
- ▶ 50.00 FPS
- ▶ 59.94 FPS
- ▶ 60.00 FPS

FILE FORMAT

Use File Format to select the format that the camera uses to record image files.

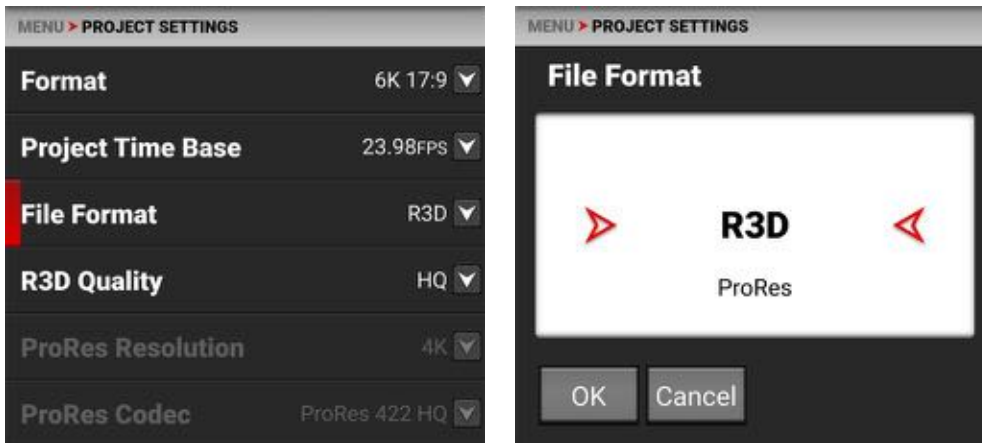

When you change the file format, a message warns you that the camera must be rebooted to complete the change:



R3D REDCODE FILE FORMAT

The RED R3D file format records images in a compressed RAW format. In comparison to Apple ProRes, REDCODE RAW data does not bake in image settings like ISO, saturation, or LUTs, allowing more flexibility in post-processing workflows without reducing image quality or dynamic range. Instead R3D files store the image settings as Metadata. You can open and process R3D files with REDCINE-X PRO or with non-linear editing (NLE) software that supports the RED SDK.

R3D is the camera's default file format.

APPLE PRORES FORMAT

This section provides general information about recording Apple ProRes files with the camera, including:

- ▶ The QuickTime file is sub-sampled by Apple ProRes when you select the unsupported **2K Apple ProRes over 120 FPS** Recording Frame Rate.
- ▶ Recording 4K Apple ProRes is only available:
 - ▶ When recording to Apple ProRes only
 - ▶ When recording to the Apple ProRes 422 HQ or ProRes 422 codec.
- ▶ QuickTime files have the same metadata that is in the REDCODE RAW files. The metadata is per clip, and not per frame. At this time, there is no tool for extracting that metadata from the QuickTime files.
- ▶ You can select any resolution. When recording Apple ProRes, the camera scales that format to the Resolution (2K or 4K) selected in the ProRes Codec menu. The field of view is maintained in the QuickTime file; the image is not cropped.
- ▶ If recording 4K Apple ProRes and the resolution is less than 4K, the image is scaled to 2K.
- ▶ For more information about Apple ProRes, including the data rates for each codec, refer to the [Apple ProRes White Paper](#).

APPLE PRORES DESCRIPTION

The table below describes each supported Apple ProRes codec.

NAME	CHROMA SAMPLING	DATA RATE
ProRes 422 HQ	Y' C _b C _r 4:2:2	3017 Mbps at 4K (4096 x 2160) and 24 FPS
ProRes 422	Y' C _b C _r 4:2:2	2011 Mbps at 4K (4096 x 2160) and 24 FPS

FILE STRUCTURE OF RECORDED APPLE PRORES FILES

When you record using ProRes format, this is the file structure of the recorded files on the media:

- ▶ .RDM Folder
 - ▶ .RDC Folder
 - ▶ .mov

The camera creates multiple .mov files, similar to how the camera creates multiple R3D files.

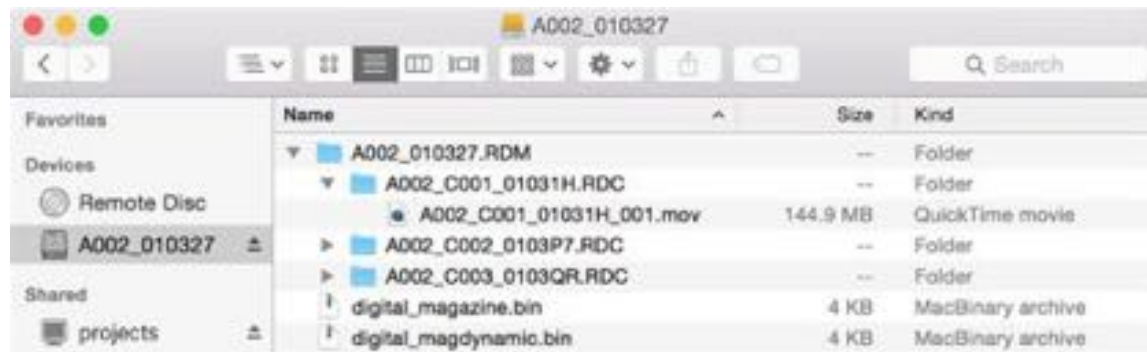

R3D QUALITY

Use R3D Quality to select the R3D data rate the camera uses to record the image files.

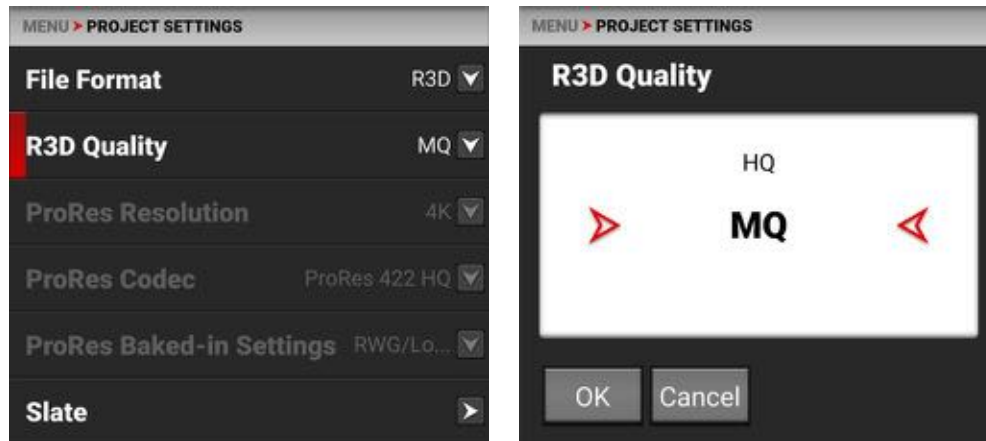

The R3D Quality selections include:

- ▶ HQ - High Quality (this selection is only enabled for some **Format** and **Project Time Base** combinations)
- ▶ MQ - Medium Quality

For VFX, extreme-detail scenes, and stills from motion we recommend HQ. For Cinema (non-VFX), TV, online content, documentary, and interviews, we recommend MQ.

PRORES RESOLUTION

When you enable ProRes as the **File Format** you can select the ProRes resolution.

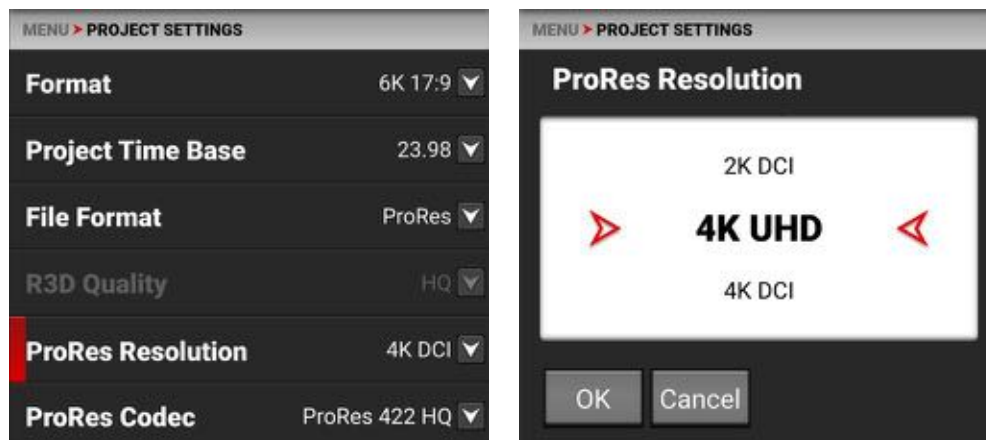

The ProRes Resolution selections include:

- ▶ 1080p
- ▶ 2K DCI
- ▶ 4K UHD
- ▶ 4K DCI

PRORES CODEC

When you enable ProRes as the **File Format** you can select the ProRes Codec.

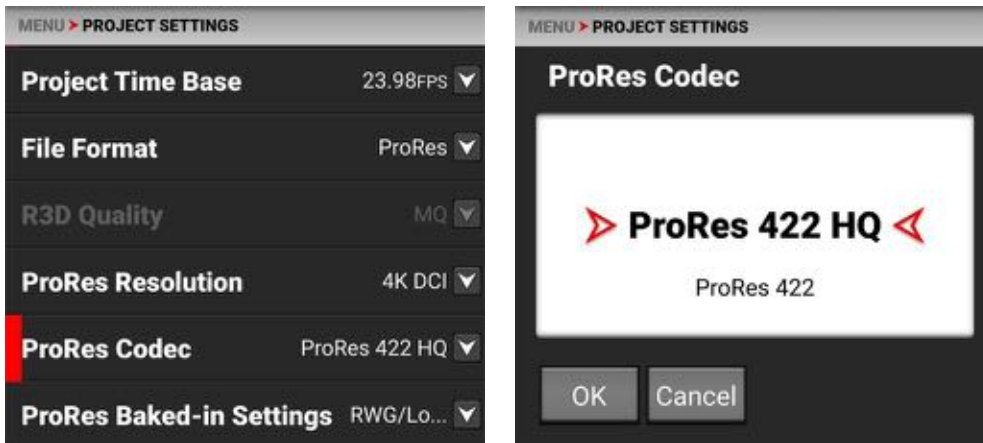

The ProRes Codec selections include:

- ▶ ProRes 422 HQ
- ▶ ProRes 422

PRORES BAKED-IN SETTINGS

When you enable ProRes as the **File Format** you can select the ProRes Baked-In settings.

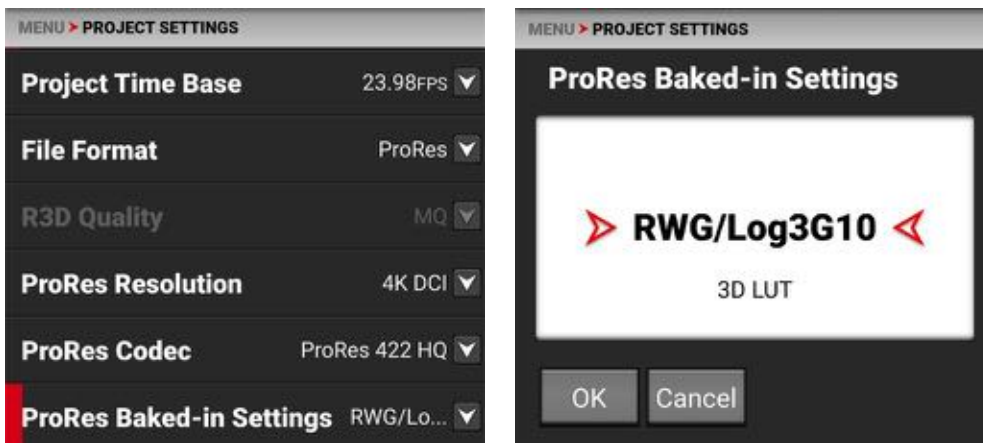

The ProRes Baked-In Settings include:

- ▶ RWG/Log3G10 - REDWideGamutRGB color space and Log3G10 gamma curve
- ▶ 3D LUT - Applies all Image / LUT settings for **Output Color Space**, **Display Preset**, **3D LUT**, and **CDL**

SLATE

Use the Slate menu to assign a camera ID and camera position to the clip.

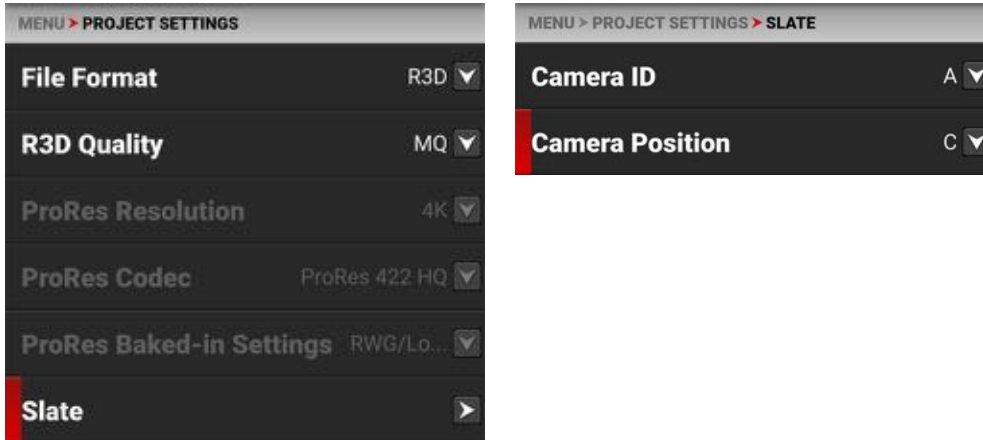

The settings you can assign to a clip include:

- ▶ Camera ID (also populates in the Media menu when formatting media)
- ▶ Camera Position (also populates in the Media menu when formatting media)

CAMERA ID

Use Camera ID to assign a camera ID to the clip.

NOTE: You can also change the Camera ID by using Secure Format (refer to [Secure Format](#))

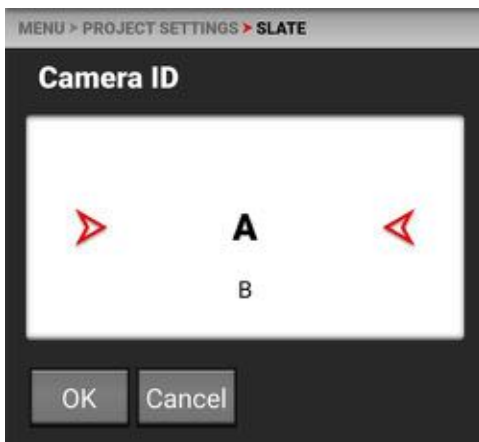

The camera IDs you can assign to a clip include the letters A-Z.

CAMERA POSITION

Use Camera Position to assign a camera position description to the clip.

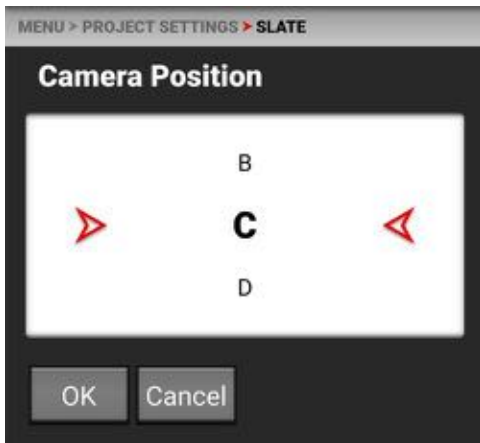

The camera positions you can assign to a clip include the letters A-Z.

AUDIO / TC MENU

The Audio / TC menu contains the settings you use to configure your camera audio and Timecode.

From the camera LCD touchscreen menu, select Audio / TC:

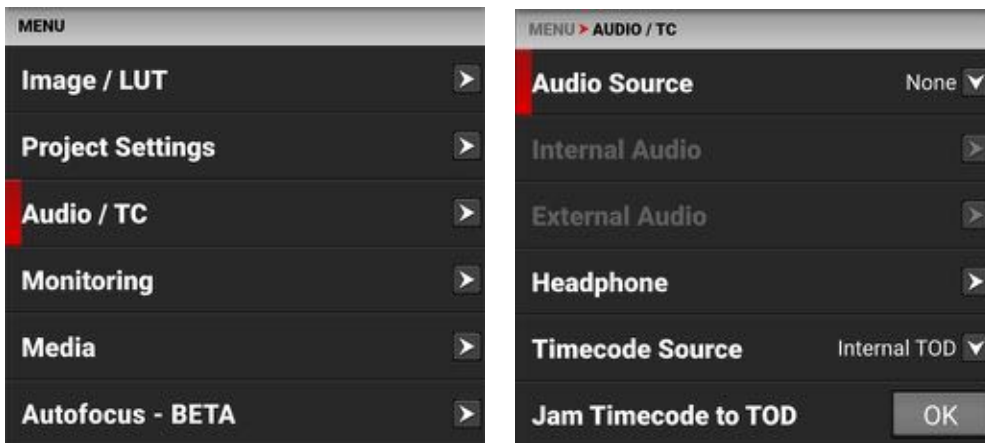

Use the Audio / TC menu to configure the audio and Timecode settings for the camera:

ITEMS	DETAILS
Audio Source	Audio input source
Internal Audio	Left and Right internal microphone levels
External Audio	Left and Right external microphone levels
Headphone	Headphone volume levels
Timecode Source	Timecode source
Jam Timecode to TOD	Button to Jam Timecode to Time of Day (TOD)
Timecode Display Mode	Timecode to display

AUDIO DETAILS

The camera is equipped with two integrated dual channel digital stereo microphones suitable for scratch-track audio, and with one 3.5 mm stereo microphone or line input.

Audio from either the scratch microphones or the external audio connector (2-channel recording) can be recorded as 24-bit 48 kHz uncompressed audio tracks.

For External audio, both Microphone Level and Line Level is supported with appropriate gain-settings.

Audio data is synchronized with video and timecode, and is embedded in the R3D file. The audio data can be exported from REDCINE-X PRO as separate audio files.

Audio is also embedded in the SDI output from the camera.

The camera is equipped with a 3.5 mm stereo headphone port for monitoring the audio during recording and playback.

TIMECODE DETAILS

Timecode provides a mechanism to reference frames from the camera's recorded clips to external devices such as, other cameras or audio recorders. Some devices can also gather additional data such as, lens metadata, or camera orientation, which Timecode can later use for merging the data back together in post-processing.

The camera provides two separate Timecode concepts:

- ▶ **Time Of Day (TOD)** - The camera records the time of day as the Timecode for each clip
- ▶ **Edgecode** - The camera records elapsed time as the Timecode for each clip. The time is reset to 01:00:00 when a new media card is inserted in the camera. All of the clips on the media will have a continuous Timecode track. However, each new media card will default to a Timecode track starting at 01:00:00. You can change the Edgecode to begin at any desired time by using the Media Format menu (refer to [Edgecode](#)).

The camera synchronizes (jams) the TOD Timecode to an external Timecode generator (when one is connected to the [Extension Port](#)) or it jams the Timecode to its internal real-time clock.

The camera stores TOD and Edge Timecode in the R3D file. You can select which one you want to display on the [LCD Touchscreen](#).

AUDIO SOURCE

Use the Audio Source settings to select the audio input source.

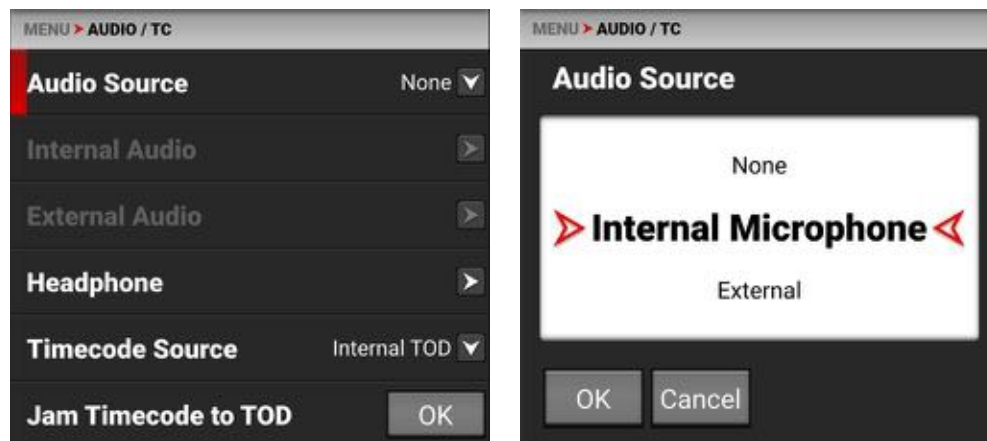

The audio input sources include:

- ▶ None
- ▶ Internal Microphone (enables the **Internal Audio** menu)
- ▶ External (enables the **External Audio** menu)

INTERNAL AUDIO

Use the Internal Audio settings to set the left and right internal audio levels. This menu is only enabled when the **Audio Source** is set to Internal Microphone.

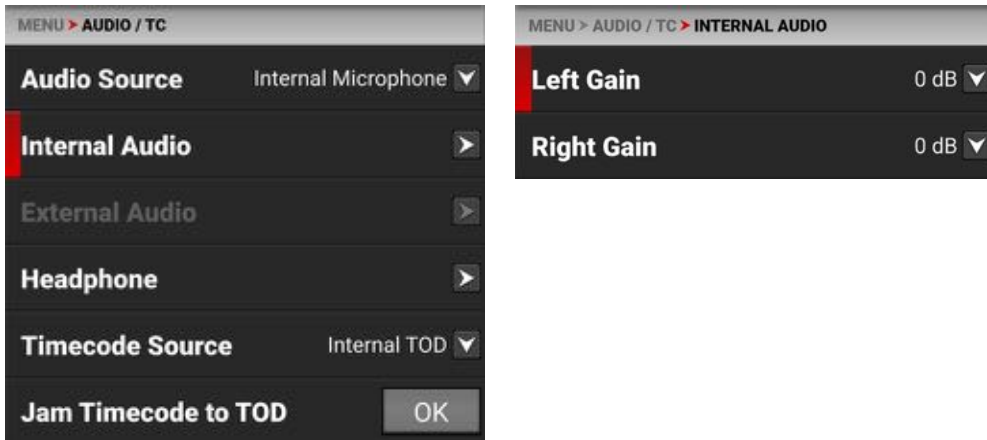

The Internal Microphone is represented as Channels 1 and 2 on the UI VU Meters (refer to **Playback** for more information). The left channel is channel 1 and the right channel is channel 2.

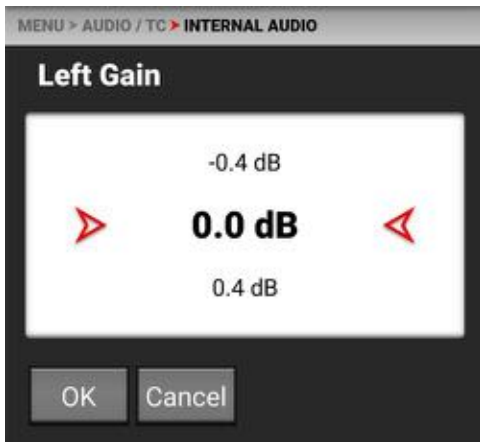

You can adjust the internal audio levels for left and right from -52.5 dB to 36.0 dB. The default setting is 0 dB.

EXTERNAL AUDIO

Use the External Audio settings to set the left and right external audio levels. This menu is only enabled when the **Audio Source** is set to External.

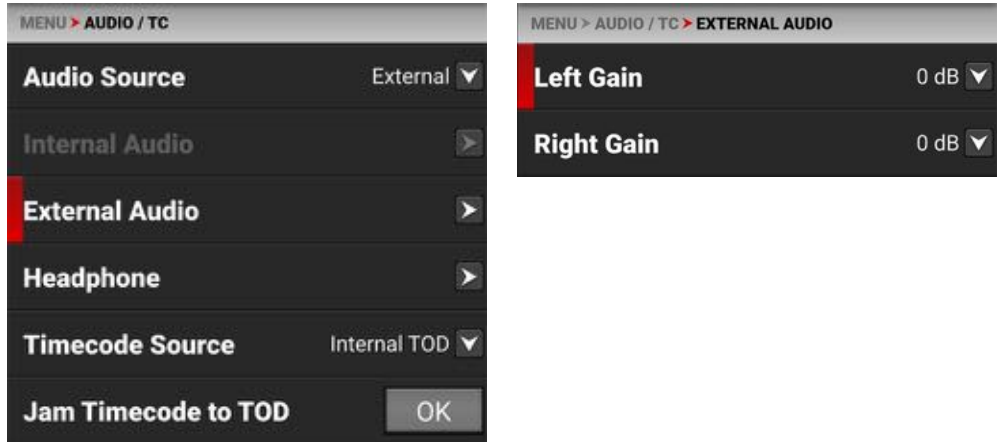

The External Microphone is represented as Channels 3 and 4 on the UI VU Meters (refer to **Playback** for more information). The left channel is channel 3 and the right channel is channel 4.

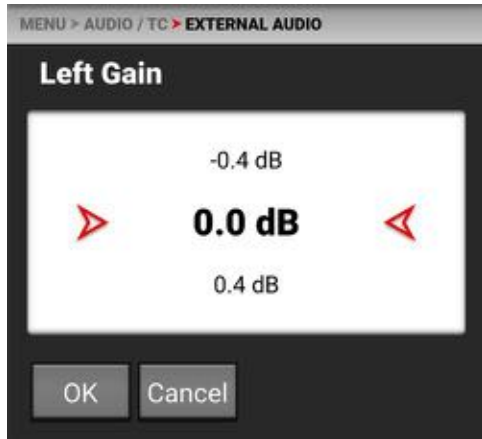

You can adjust the external audio levels for left and right from -52.5 dB to 36.0 dB. The default setting is 0 dB.

HEADPHONE

Use the Headphone settings to enable the headphone jack and to adjust the headphone volume.

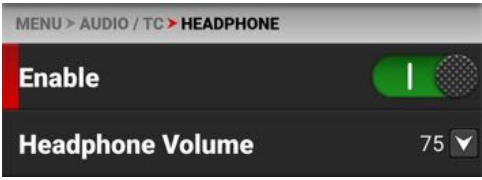
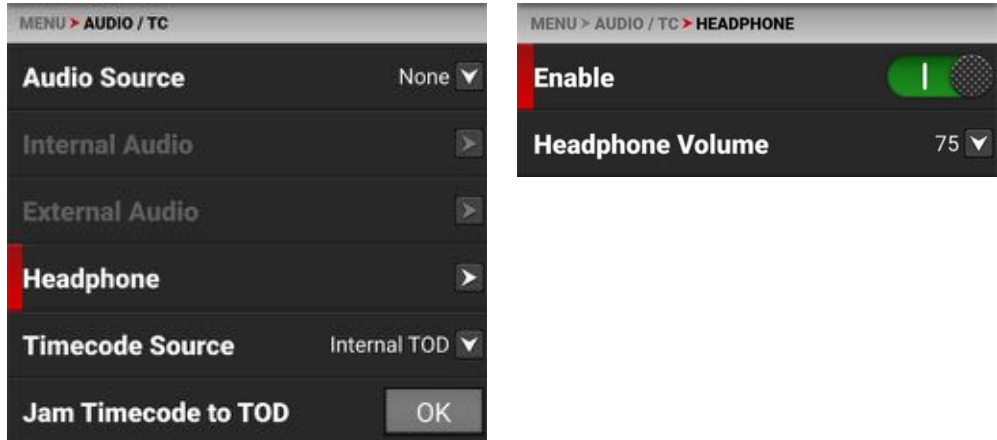

You can enable and disable the headphone audio jack by tapping the Enable toggle to the right (green) and to the left (red).



You can adjust the headphone volume from 0 to 100.



TIMECODE SOURCE

Use Timecode source to configure the Timecode source the camera applies to the recordings.

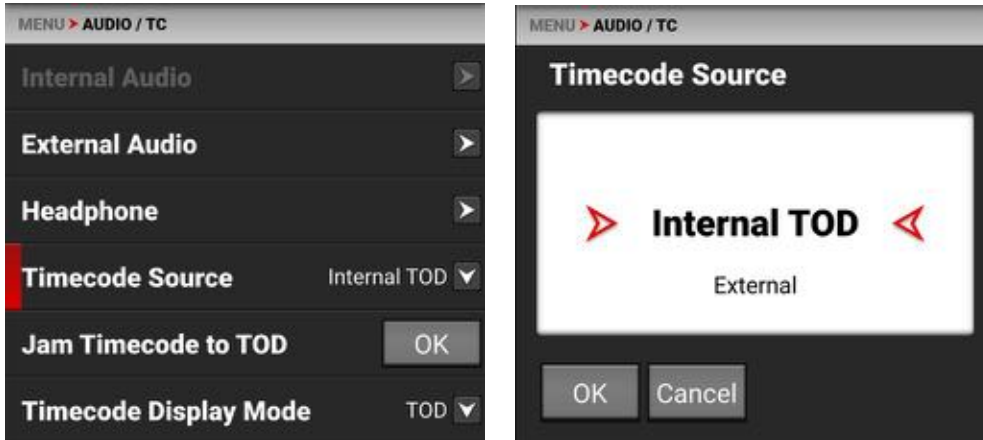

You can set the Timecode source as Internal Time of Day (TOD) or External.

When you set the camera Timecode source to External, you can connect an external Timecode generator to the [Extension Port](#).

TIMECODE DISPLAY MODE

Use Timecode Display Mode to configure the Timecode display type that the camera applies to the recordings.

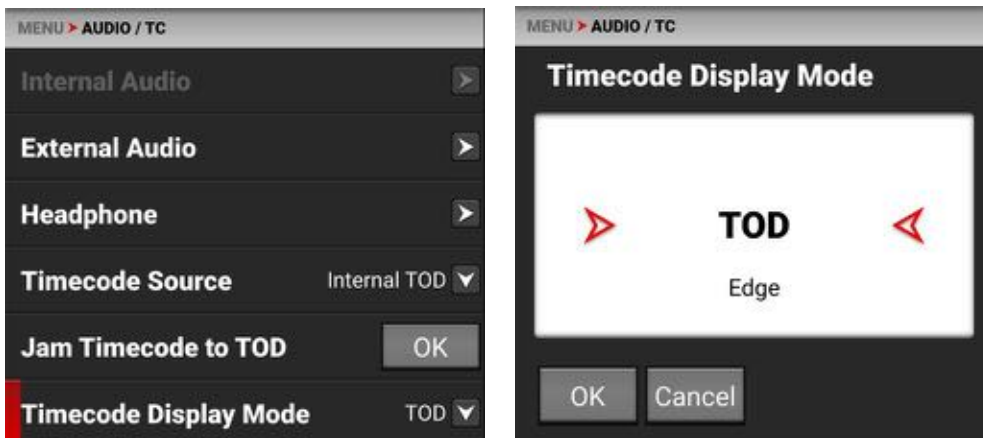

You can set the Timecode Display Mode as Time of Day (TOD) or Edge.

TOD DISPLAY MODE

Time of Day (TOD) display mode displays the Timecode as the time of day that the frame was recorded.

EDGE DISPLAY MODE

Edge display mode displays the Timecode as the sequential recording time that has elapsed starting with the first frame.

MONITORING MENU

The Monitoring menu contains the settings you use to configure your camera monitoring options.

From the **LCD Touchscreen** menu, select Monitoring:

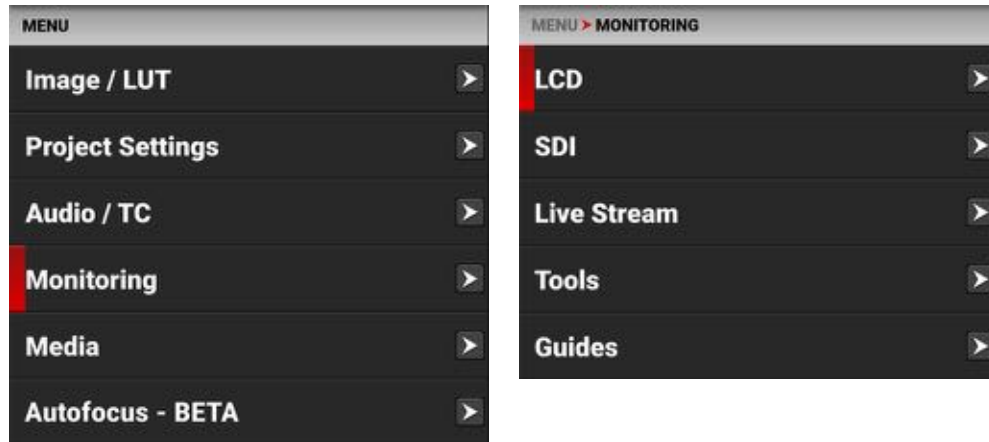

Use the Monitoring menu to configure the monitoring settings:

ITEMS	DETAILS
LCD	LCD Touchscreen settings
SDI	SDI port frequency and resolution
Live Stream	Enable or disable WiFi live streaming
Tools	Various monitoring tools including False Color, Peaking, and Zebra Modes
Guides	Frame guides and a center guide

LCD

Use LCD to configure the **LCD Touchscreen** settings.

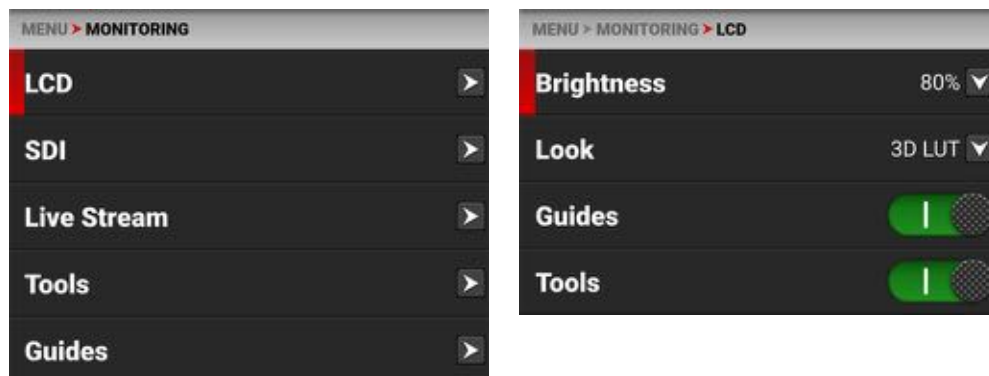

The LCD settings you can configure include:

ITEMS	DETAILS
Brightness	Adjust the LCD touchscreen brightness
Look	Select the 3D LUT, or RWG and Log3G10 image preview look
Guides	Enable or Disable the camera guides
Tools	Enable or Disable the camera tools

BRIGHTNESS

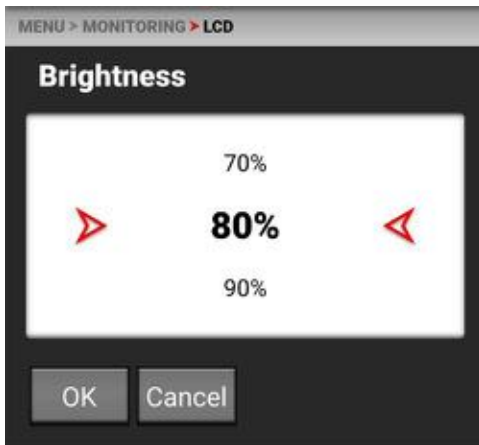

You can adjust the camera's top LCD brightness from 10% to 100%.

LOOK

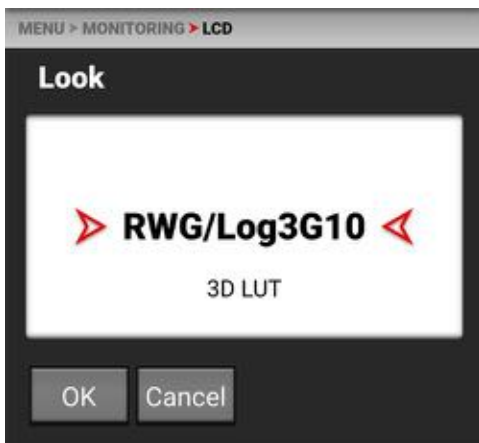

You can select the look of the image preview on the LCD. The selections include:

- ▶ REDWideGamutRGB/Log3G10
- ▶ 3D LUT.

GUIDES

Use the toggle to enable or disable the camera guides.

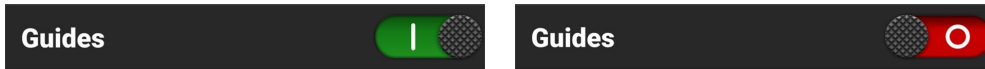

TOOLS

Use the toggle to enable or disable the camera tools.



SDI

Use SDI to configure the SDI port settings.

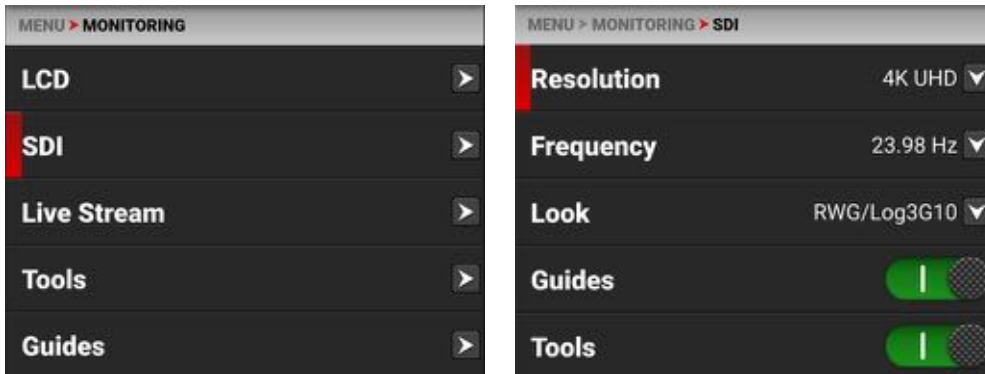

The SDI port settings you can configure include:

ITEMS	DETAILS
Resolution	Select the SDI port resolution
Frequency	Select the SDI port frequency
Look	Set the look of the playback between RWG/Log3G10 or 3D LUT
Guides	Enable or Disable the camera guides
Tools	Enable or Disable the camera tools

RESOLUTION



Use Resolution to select one of the following SDI port resolution settings:

- ▶ 1080p
- ▶ 2K DCI
- ▶ 4K UHD
- ▶ 4K DCI

The resolution selected here controls the SDI output resolution of the recording.

SCALING PREVIEW

When monitoring in 1080p or 4K UHD while capturing in a 17:9 format, the entire 17:9 image will be down-scaled to the 16:9 aspect ratio of 1080p or 4K UHD. Small black bars will only appear on the top and bottom of the frame in the monitor path and not on the recorded image.

FREQUENCY

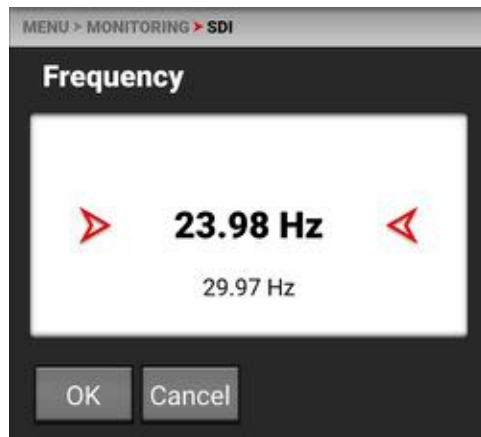

Use Frequency to select one of the following SDI port frequency settings:

- ▶ 23.98 Hz
- ▶ 29.97 Hz
- ▶ 59.94 Hz

LOOK

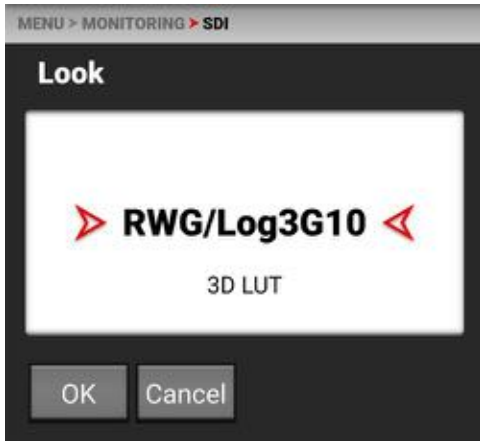

You can select the look of the image preview signal sent to the SDI port.

The selections include:

- ▶ REDWideGamutRGB / Log3G10
- ▶ 3D LUT

GUIDES

Use Guides to enable or disable the viewing of guides. Tap the switch to toggle between enabled and disabled.



TOOLS

Use Tools to enable or disable the viewing of tools. Tap the switch to toggle between enabled and disabled.



SDI PORT DESCRIPTION

The Serial Digital Interface (SDI) port allows the camera to deliver 12 Gbps of image bandwidth with greater resolution, frame rates, and color fidelity. This single BNC cable solution makes it ideal for the 4Kp60 format.

The SDI port is located on the back of the camera body.



For more information about the SDI standard, refer to the SMPTE (Society of Motion Picture and Television Engineers) standard SMPTE ST-2082.

LIVE STREAM

Use Live Stream to enable or disable live streaming over WiFi.

NOTE: When live streaming, select 5 GHz as the WiFi band (refer to **Ad-Hoc**).

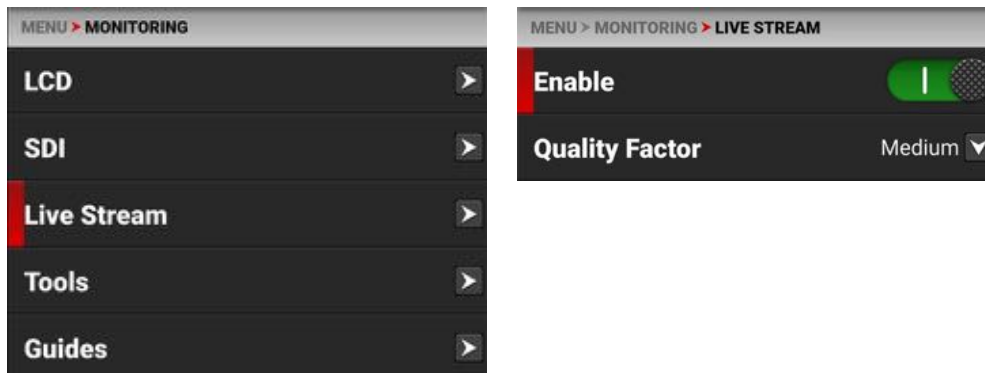

ENABLE

Use Enable to enable or disable the Live Stream feature.



QUALITY FACTOR

Use Quality Factor, when Live Streaming is enabled, to control the video quality the camera's output stream. Lower quality can stream over a longer distance.

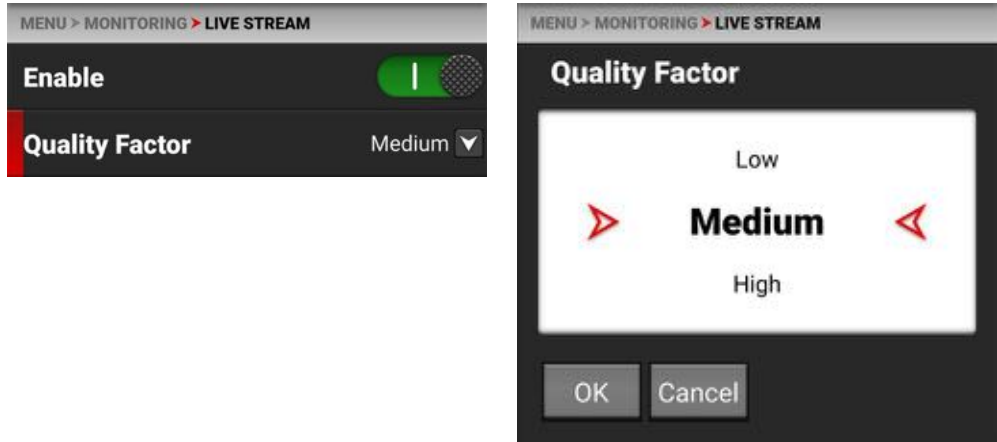

TOOLS

The Tools menu provides access to the monitoring tools.

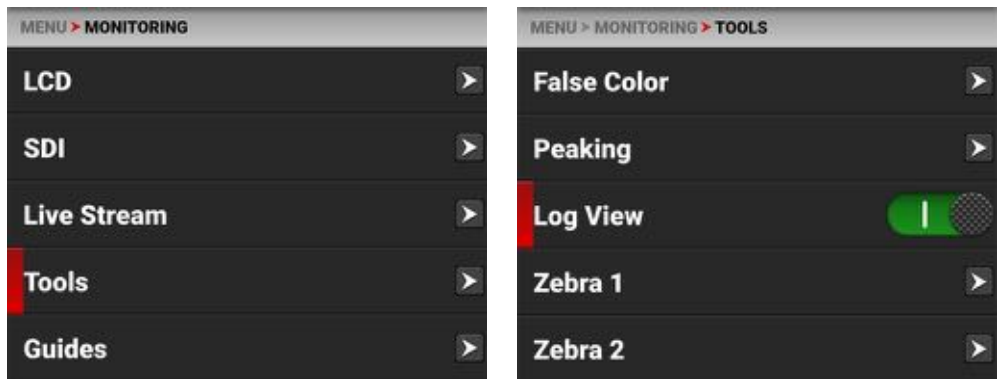

The monitoring tools that you can use include:

ITEMS	DETAILS
False Color	Enable and configure the False Color Exposure Mode and the False Color Video Mode
Peaking	Enable and configure focus indicating modes
Log View	Enable or Disable Log View
Zebra 1	Enable and configure Zebra 1 settings
Zebra 2	Enable and configure Zebra 2 settings

FALSE COLOR

Use False Color to configure the False Color tool settings.



The False Color tool settings you can configure include:

ITEMS	DETAILS
Enable	Enable or disable the False Color tool modes
False Color Mode	Select the False Color tool mode

ENABLE

Use Enable to enable or disable the False Color tool.



FALSE COLOR MODE

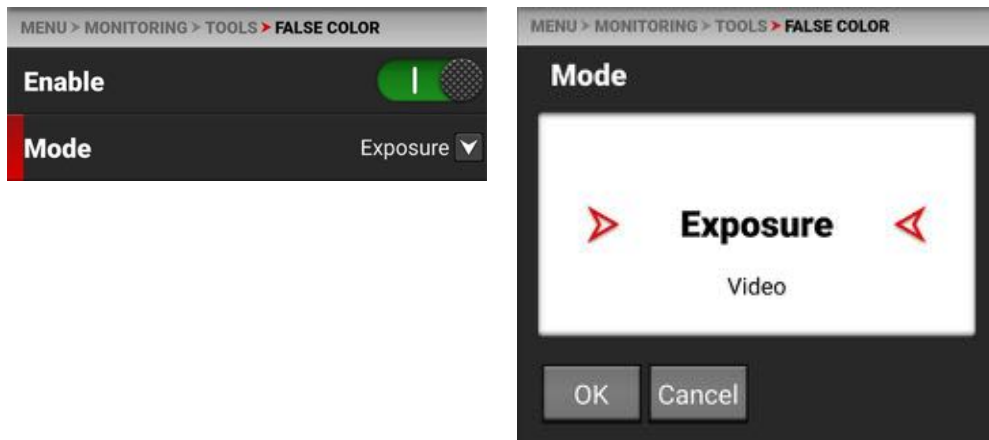

False Color Modes include:

ITEMS	DETAILS
False Color Exposure Mode	Use false colors to determine an optimal balance between overexposure and underexposure.
False Color Video Mode	Access scene exposure in varying light without relying on the LCD image brightness.

NOTE: False Color modes display on video recorded through SDI to an external recorder when the Tools are enabled in the Monitor menu. When recording through SDI, use False Color modes only to help determine scene exposure settings, and then disable the mode before recording.

FALSE COLOR EXPOSURE MODE

When this monitoring **False Color** mode is activated, most of the tonal range will appear in monochrome.

NORMAL VIEW



EXPOSURE MODE VIEW



NOTE: The false colors will appear in the same location regardless of ISO setting. To change their appearance, you must alter the amount of light entering the camera (by adjusting lighting, shutter speed or lens aperture).

Exposure mode is able to indicate exactly which highlights or shadows are problematic in the RAW data capture. If red is overlaid within the subject of interest, or anywhere except lights and direct reflections, then the image is very likely overexposed. If there aren't any red overlays, then the exposure is likely OK and could even be increased. If purple is overlaid on key image detail that isn't in the shadows, then the scene is likely underexposed.

FALSE COLOR VIDEO MODE

NOTE: For best results, Video Mode should be viewed at or above ISO 800.

Video Mode displays a color overlay that indicates the video level of the RGB monitor path (calibrated to the SMPTE test signal).

NORMAL VIEW



VIDEO MODE VIEW

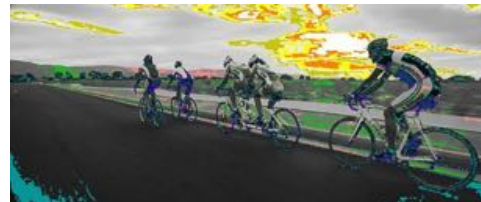

The colors used are based on the RGB levels of the video out signal (that is, the “cooked” look, and not RAW data). The camera's RGB settings can change the appearance of the Video Mode colors.

The Video Mode colors represent the following IRE values (at all other values, the desaturated image represents the luminance value of the ISO adjusted image):

- ▶ Purple: IRE 0–4
- ▶ Blue: IRE 5
- ▶ Teal: IRE 10–12
- ▶ Green: IRE 41–48
- ▶ Pink: IRE 61–70
- ▶ Straw: IRE 92–93
- ▶ Yellow: IRE 94–95
- ▶ Orange: IRE 96–98
- ▶ Red: IRE 99–100.

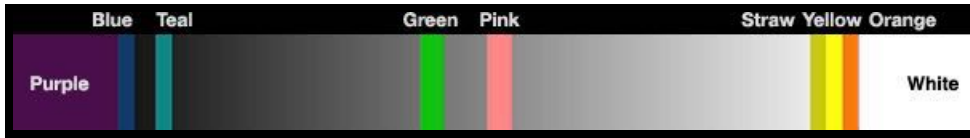

Green is where you will want 18% gray, Pink is typically the brightness of Caucasian skin tones, Straw, Yellow, and Orange are strong highlights and increasingly closer to white, Teal is deep shadows and Blue is on the verge of becoming untextured black. In general, Pink and Green are most helpful when calibrating based on a known reference, whereas the other colors indicate the extremes of a tonal range.

A potential disadvantage of False Color Video mode is that all the false colors can distract from the underlying preview. Many prefer to use this mode only during initial set-up, and then they use **False Color Exposure Mode** under a wider range of scenarios.

IN PRACTICE

In **False Color Exposure Mode**, use the purple and red indicators to adjust your lighting or lens aperture. Use this strategy to achieve an optimal balance between clipping from overexposure and image noise from underexposure. With most scenes, you can often have a surprising range of exposure latitude before excessive red or purple indicators begin to appear.

If necessary, use False Color Video mode or **Zebra Modes** to fine-tune how the scene will appear over SDI, or use it to adjust your suggested look when sending footage for post-production.

The Zebra and Video modes are also an objective way to assess the scene exposure under varying ambient light without relying on the LCD image to evaluate brightness.

PEAKING

The Peaking tools display contrast, outlines, or colors to assist with focusing.

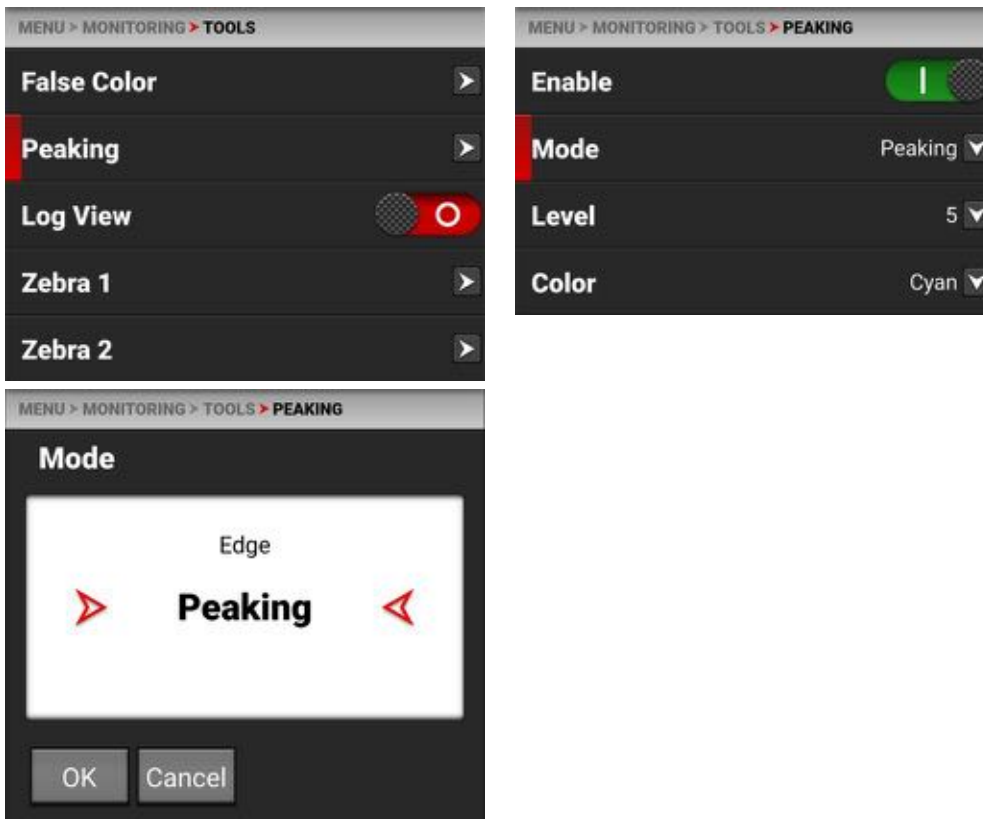

The Peaking modes you can use include:

ITEMS	DETAILS
Focus	Use enhanced contrast and edges for focusing
Edge	Show outlines of focused objects
Peaking	Select a colored overlay to indicate objects in focus

FOCUS PEAKING MODE

Focus Peaking mode emphasizes contrast and edges in the image without changing the brightness or the image content. This mode makes it easier to judge focus. Adjust the zoom and focus to easily see which objects are coming into focus.

EDGE PEAKING MODE

When you enable Edge Peaking mode, the display shows the edges or outlines of objects that are in focus.

PEAKING PEAKING MODE

The Peaking Peaking mode displays a color overlay on top of in-focus edges. Select a Level of 1 to 10 (weak to strong) for the intensity of the color overlay. The RGB settings can change the appearance of the selected color overlay.

The Peaking Peaking mode indicator is applied after the image is scaled to a monitor, making the indicators appear differently on various monitors.

For more information about Peaking, refer to [Focus](#) in the [How To](#) section.

LOG VIEW

Use Log View to display camera images in REDWideGamutRGB and Log3G10 for the ISO, Exposure Adjust, Color Temperature, and Tint settings. This allows you to quickly see ungraded footage that remains unaffected by creative decisions such as the choice of 3D LUT or CDL.

Log View is passed through the SDI port when recording to an external recorder. You can view the Log image in playback on the LCD and on the monitor. However, Log View is not recorded to the file recorded on the media card.

Log View is only enabled on R3D files and not on ProRes files.

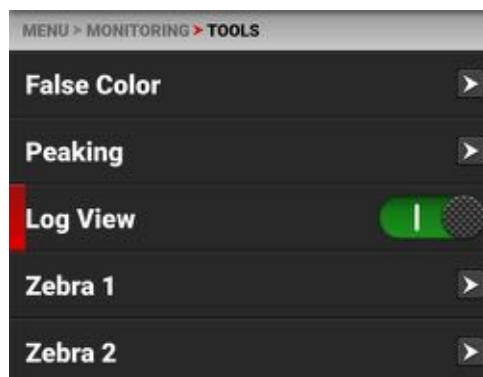

Use the slider to switch from Enabled to Disabled:



ZEBRA 1

Use Zebra 1 to display one set of diagonal stripes to indicate highlight exposure levels. For more information, refer to [Zebra Modes](#).

Zebra 1 is disabled by default.

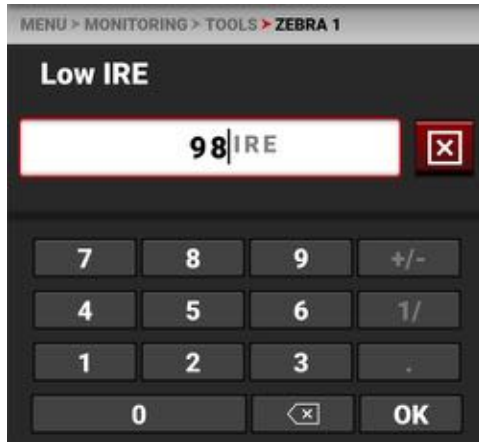
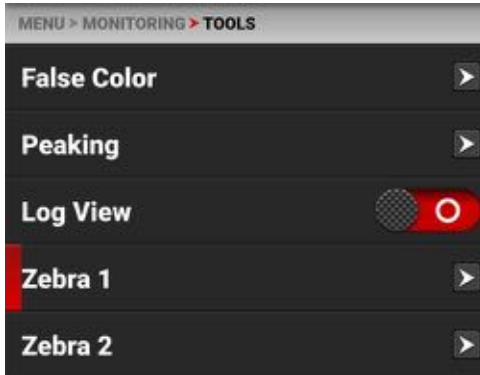

The Zebra 1 mode includes:

ITEMS	DETAILS
Enable	Enables red zebra stripes to indicate highlight exposure
Low IRE	Sets the lower threshold for the indicator
High IRE	Sets the higher threshold for the indicator

ENABLE

The Enable toggle switch allows you to enable or disable the Zebra 1 stripes.

LOW IRE

Provides a keypad that allows you to set the low threshold for the Zebra stripe. The default setting is 98 IRE.

HIGH IRE

Provides a keypad that allows you to set the high threshold for the Zebra stripe. The default setting is 100 IRE.

NORMAL VIEW



ZEBRA 1 VIEW



ZEBRA 2

Use Zebra 2 to display a second set of diagonal stripes to indicate mid-tone and shadow levels. For more information, refer to [Zebra Modes](#).

Zebra 2 is disabled by default.

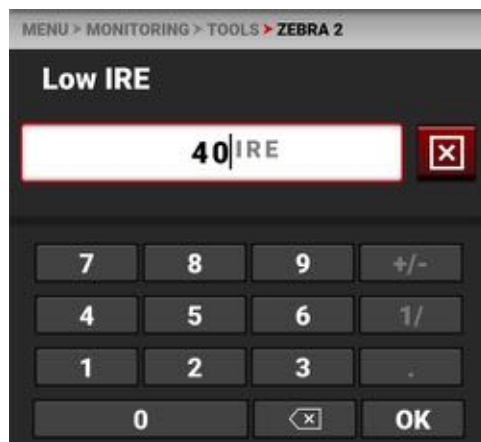
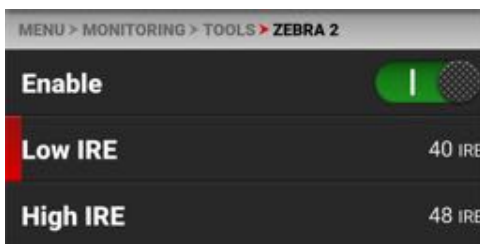
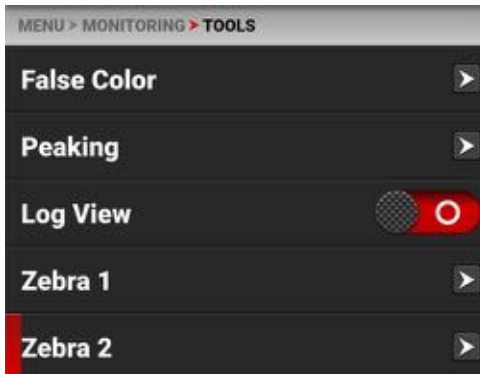

The Zebra 2 mode includes:

ITEMS	DETAILS
Enable	Enables green zebra stripes to indicate mid-tone and shadow exposure
Low IRE	Sets the lower threshold for the indicator
High IRE	Sets the higher threshold for the indicator

ENABLE

The Enable toggle switch allows you to enable or disable the Zebra 2 stripes.

LOW IRE

Provides a keypad that allows you to set the low threshold for the Zebra stripe. The default setting is 40 IRE.

HIGH IRE

Provides a keypad that allows you to set the high threshold for the Zebra stripe. The default setting is 48 IRE.

NORMAL VIEW



ZEBRA 1 VIEW



ZEBRA 2 VIEW



GUIDES

Use Guides to enable and configure the camera's monitoring guides.

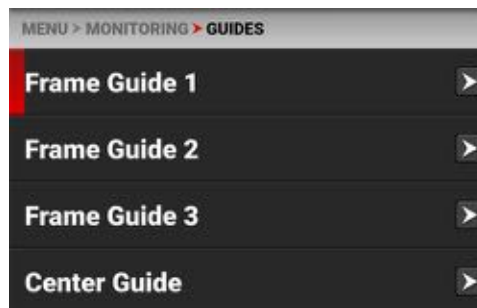
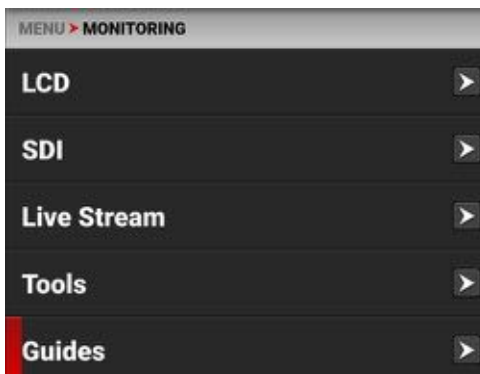

The monitoring Guides that you can use include:

ITEMS	DETAILS
Frame Guides	Guides you can configure to aid in framing a shot
Center Guide	A center cross hair or dot you can use to center your shot

FRAME GUIDES

Use Frame Guides to frame the scene using various shapes and sizes. You can configure up to 3 Frame Guides to display on your monitor.

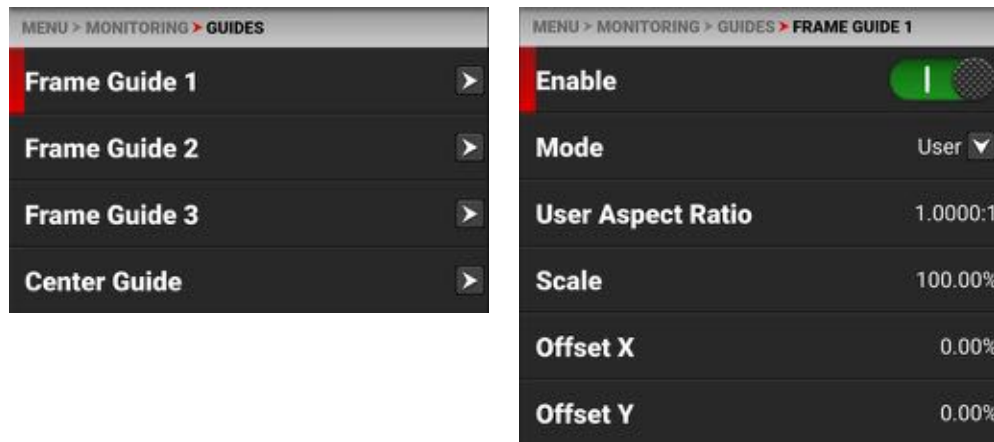

Configure the Frame Guides using the following:

ITEMS	DETAILS
Enable	Enables the Frame Guide
Mode	Select aspect ratios, User, and Absolute modes
User Aspect Ratio	Enabled by selecting User mode
Scale	Percentage of the screen the Frame Guide occupies
Offset X, Y	Percentage of horizontal and vertical offset
Absolute X, Y, W, H	Absolute mode - set the exact number of size and offset pixels
Line Style	Select the Frame Guide line type - solid, dashed or bracket
Color	Select the Frame Guide line color
Opacity	Select the Frame Guide line opacity

MODE

Use Mode to select the Frame Guide mode you want to use to configure the frame guide.

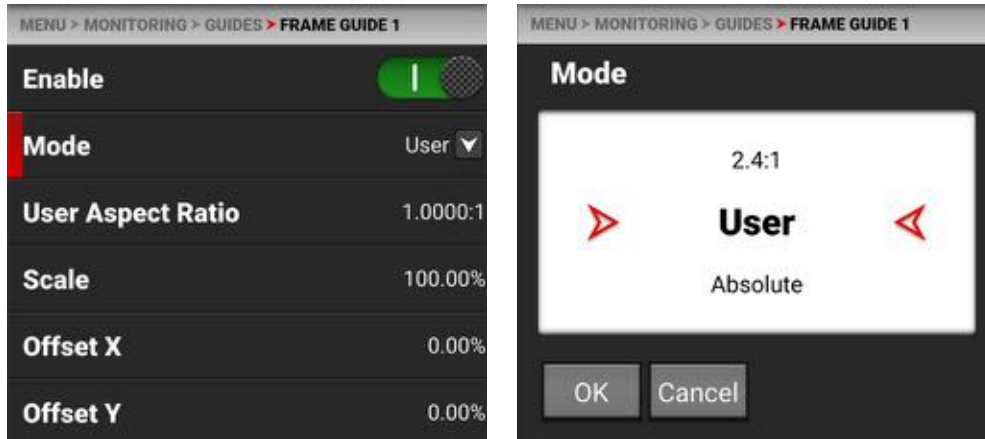

The modes you can select include aspect ratios from Full to 2.4:1, User, and Absolute. The User and Absolute modes enable settings that are specific to those modes.

USER ASPECT RATIO

This item is enabled when the User mode is selected.

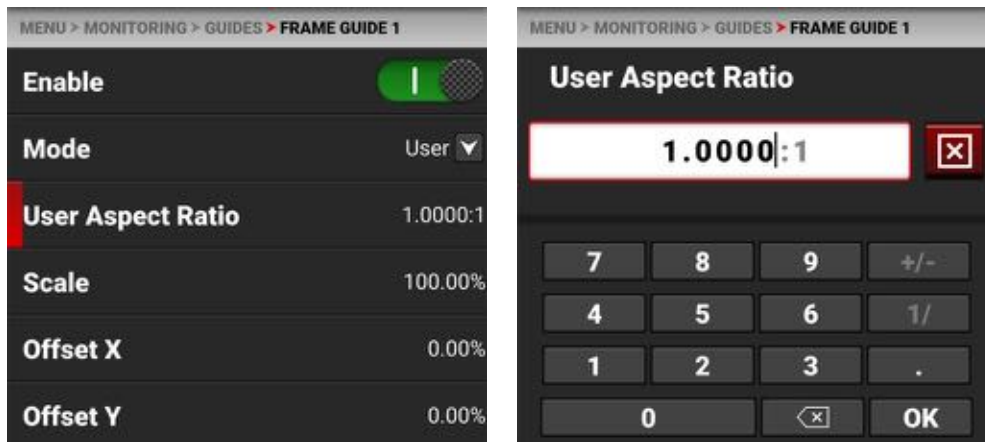

Use the keypad to enter your desired aspect ratio.

SCALE

Use scale to configure the percentage of the image area that the Frame Guide will frame.

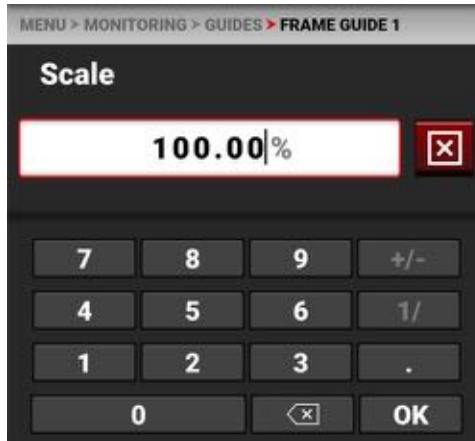
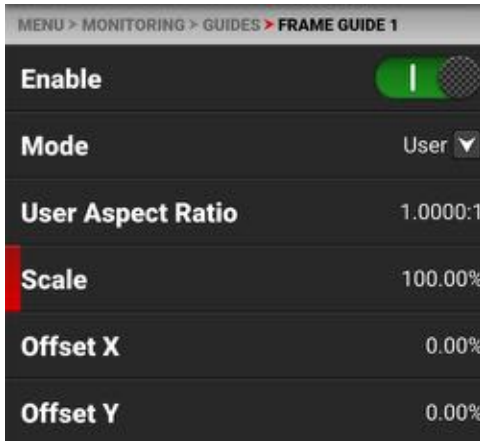

Use the keypad to enter the percentage of the image the Frame Guide contains.

OFFSET X, Y

Use offset to configure the X and Y offset of the Frame Guide.

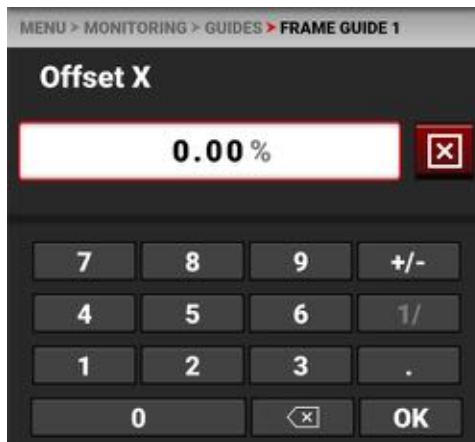
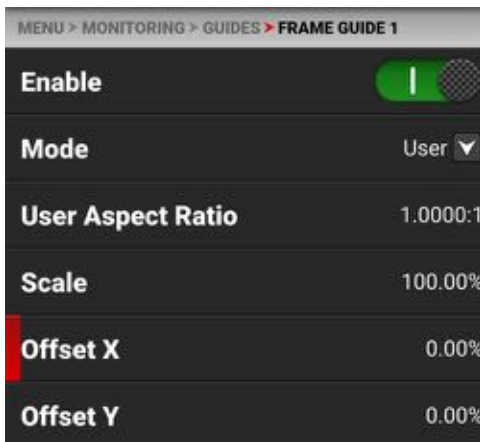

Use the keypad to enter the percentage of offset from center you want to apply to the Frame Guide.

ABSOLUTE X, Y, W, H

Use the Absolute settings to configure the absolute dimensions and position of the Frame Guide.

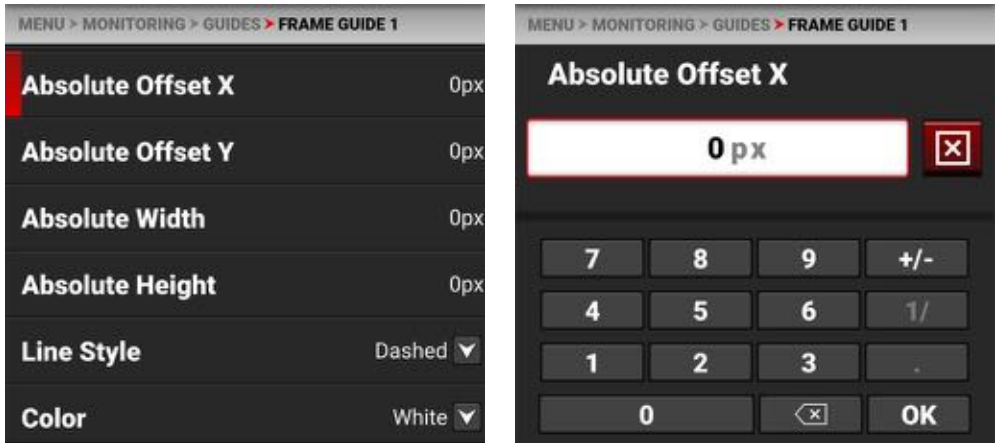

Use the keypad to enter the number of pixels for X/Y offset and for the width and height of the Frame Guide. The Absolute items are only enabled when you select Absolute **Mode**.

LINE STYLE

Use Line Style to select the type of line the Frame Guide uses.

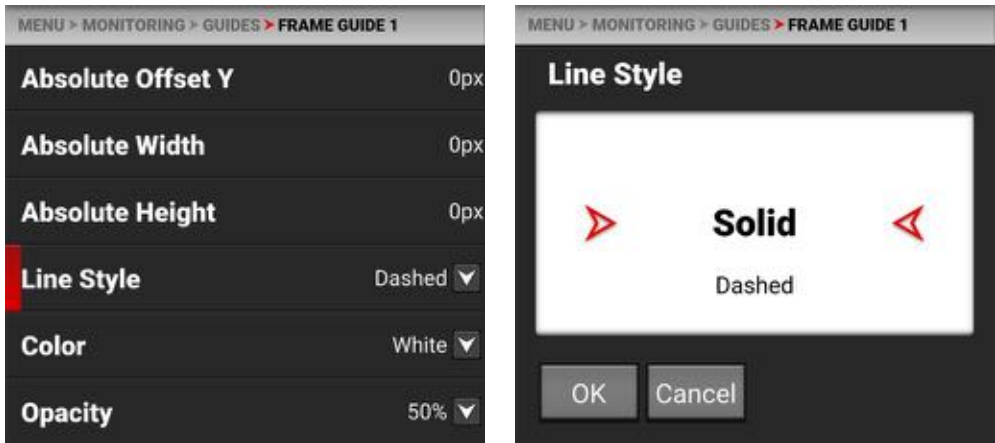

Select Solid, Dashed, or Bracket for the Frame Guide line style.

COLOR

Use Color to select the color of the Frame Guide line.

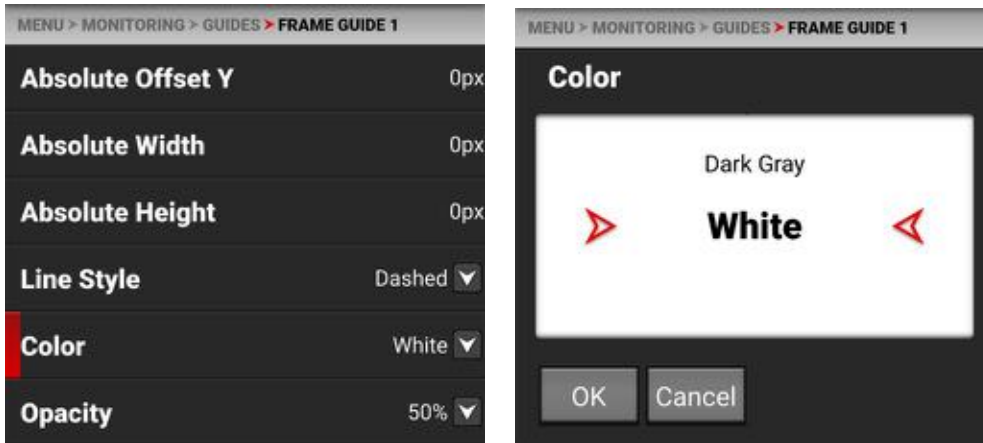

Use Color to select one of the following colors for the Frame Guide:

- ▶ Black ▶ Green ▶ Cyan
- ▶ Red ▶ Yellow ▶ Dark Gray
- ▶ Blue ▶ Magenta ▶ White

OPACITY

Use Opacity to select how transparent the Frame Guide line appears.

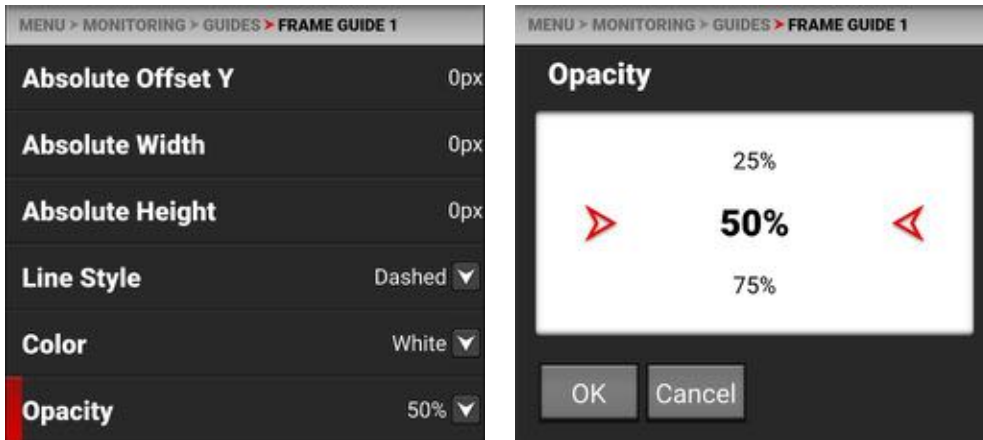

Use Opacity to select the percentage of opacity for the Frame Guide:

- ▶ 25%
- ▶ 50%
- ▶ 75%
- ▶ 100%

CENTER GUIDE

Use Center Guide to enable and configure the Center Guide.

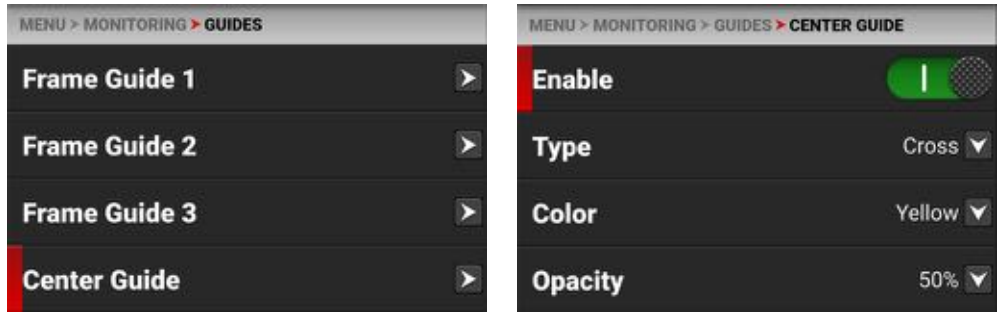

Configure the Center Guide by using the following:

ITEMS	DETAILS
Enable	Enables the Center Guide
Type	Select Center Guide type - dot or cross
Color	Select a color for the Center Guide
Opacity	Percentage of opacity of the guide color

TYPE

Use Type to select the type of Center Guide to display.

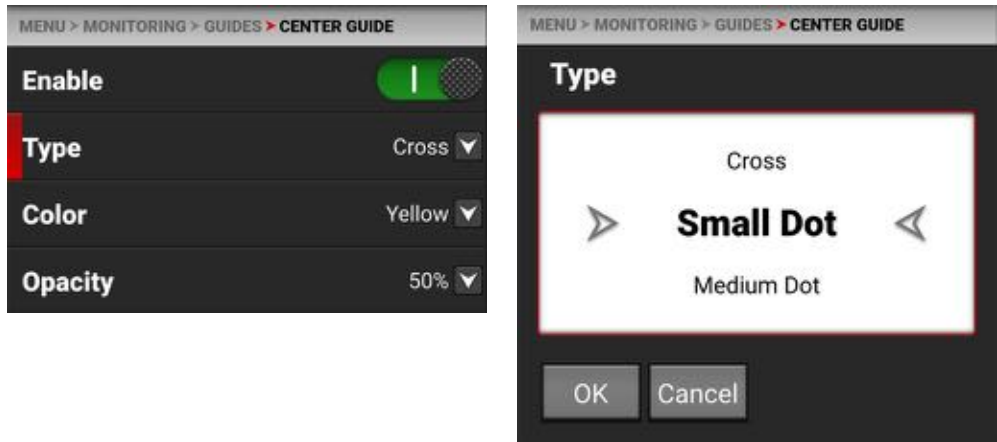

Use Type to select a center dot or cross-hairs for the Center Guide.

COLOR

Use Color to select the color used by the Center Guide.

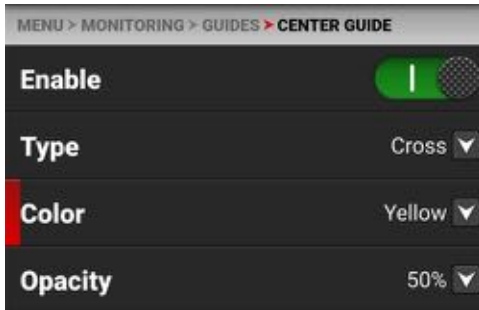

Use Color to select one of the following colors for the Center Guide:

- ▶ Black ▶ Green ▶ Cyan
- ▶ Red ▶ Yellow ▶ Dark Gray
- ▶ Blue ▶ Magenta ▶ White

OPACITY

Use Opacity to select how transparent the Center Guide appears.

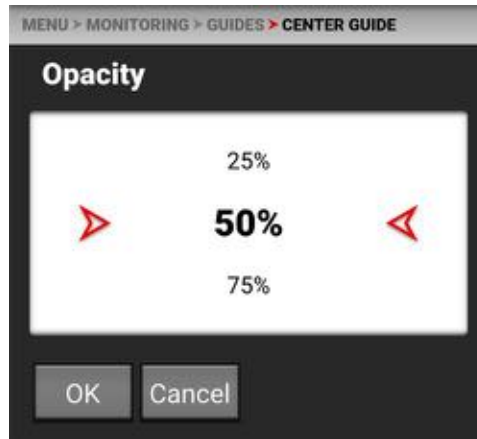
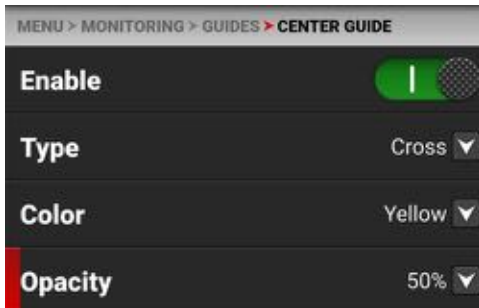

Use Opacity to select the percentage of opacity for the Center Guide:

- ▶ 25%
- ▶ 50%
- ▶ 75%
- ▶ 100%

MEDIA MENU

The Media menu contains the settings you use to configure your media.

From the camera LCD touchscreen menu, select Media:

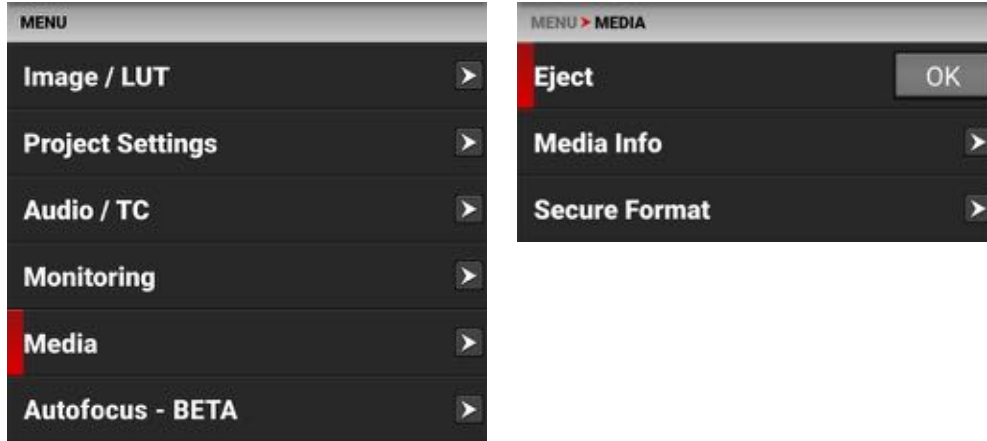

Use the Media menu to configure the camera's storage media settings and to view the media information:

ITEMS	DETAILS
Eject	Eject the CFast media card
Media Info	View the CFast media card information
Secure Format	Performs a secure format of the CFast media card

EJECT

Use Eject to safely eject the CFast media card.

WARNING: The media can get extremely hot. Use caution when removing media.

Access Eject from the [LCD Touchscreen](#) Media menu:



For more information, refer to [Media Management](#).

MEDIA INFO

Use Media Info to display the CFast media card information.

Access Media Info from the **LCD Touchscreen** Media menu:

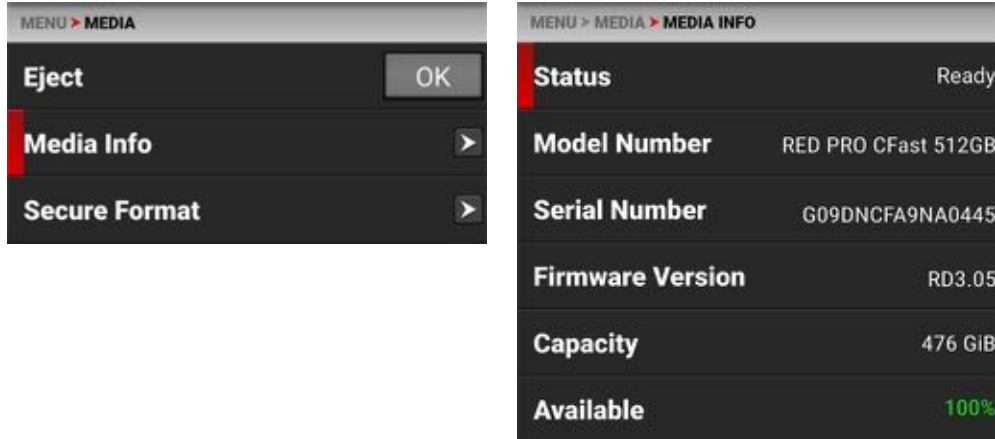

Media Info displays the following:

SETTING	DETAILS
Status	Displays the CFast media card status
Model Number	Displays the CFast media card model number
Serial Number	Displays the CFast media card serial number
Firmware Version	Displays the CFast media card firmware version
Available	Displays the CFast media card's remaining storage
Time Remaining	Displays the recording time remaining on the CFast media card

SECURE FORMAT

Use Secure Format to format the CFast media card down to the file system level.

A secure format allows you to rebuild the card file system.

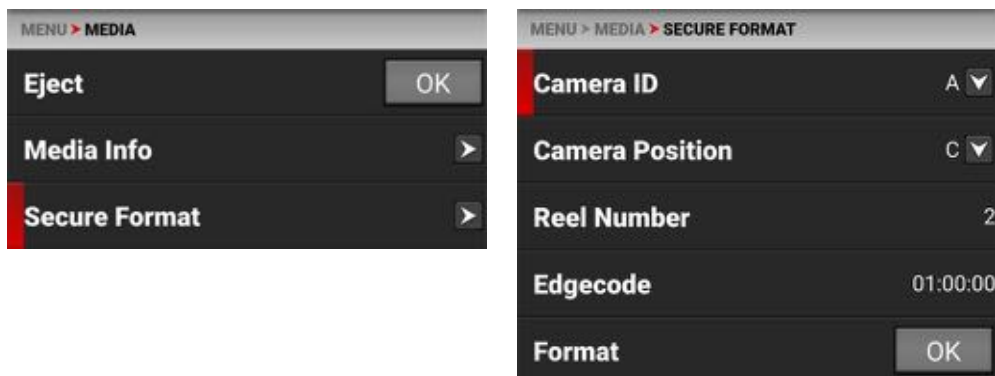

Use the Secure Format menu to update the following information:

SETTING	DETAILS
Camera ID	Select the camera ID (default is A)
Camera Position	Select the camera position (default is C)
Reel Number	Select the reel number (default is 1)
Edgecode	Enter the time number (default is 01:00:00)
Format	Starts the Secure formatting process

For more information, refer to [Secure Format](#).

CAMERA ID

Use Camera ID to assign a camera ID letter to the media.

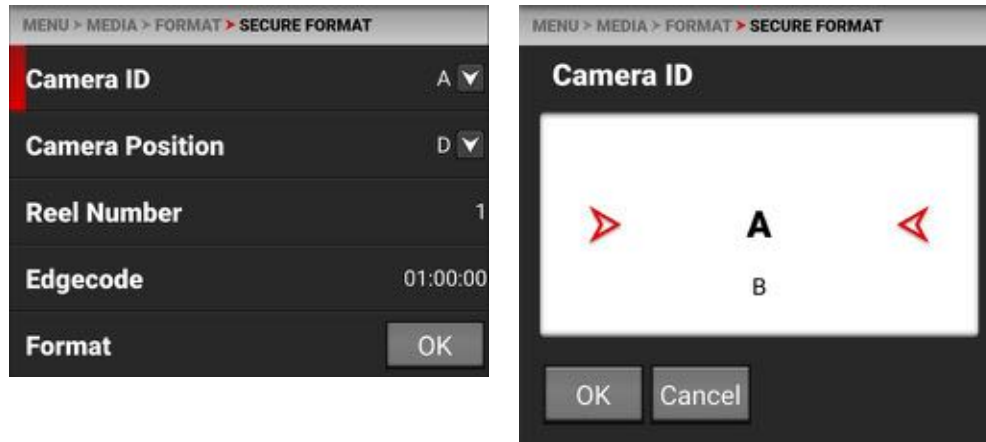

The Camera ID letters you can assign range from A-Z. For more information, refer to [Secure Format](#).

CAMERA POSITION

Use Camera Position to select the camera position label for the CFast media card.

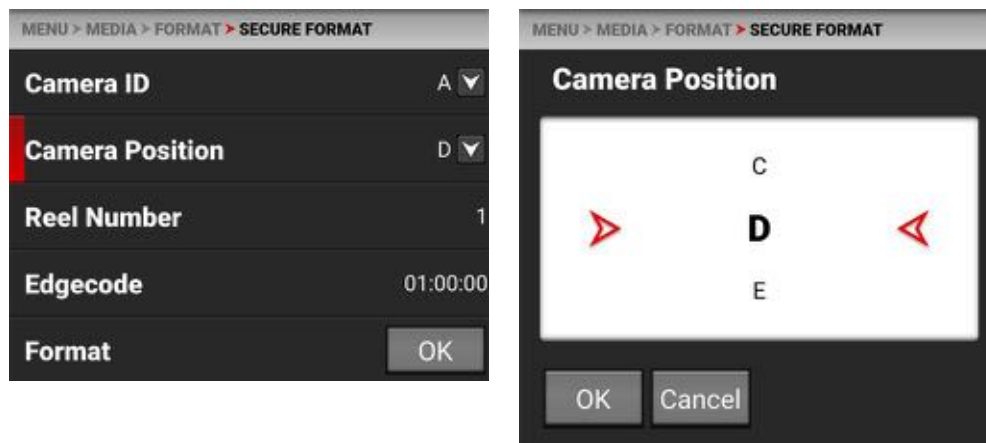

The Camera Position letters you can assign range from A-Z. For more information, refer to [Secure Format](#).

REEL NUMBER

Use Reel Number to assign a reel number to the media.

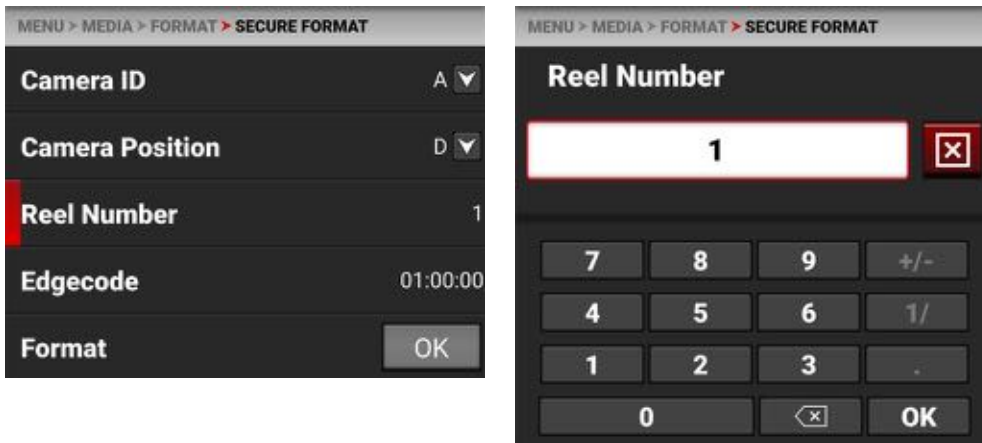

Use the keypad to enter a unique reel number to the media.

NOTE: It is best practice to keep your reel numbers to no longer than seven characters in length to conform with all EDL formats.

For more information, refer to [Secure Format](#).

EDGECODE

Use Edgecode to assign an edge code to the media.

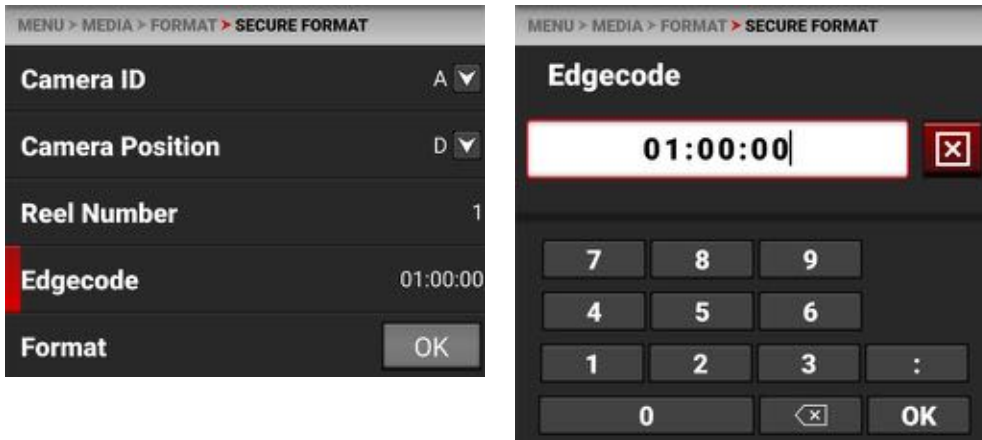

Use the keypad to enter a unique edge code number to the media.

Edge Code is a SMPTE Timecode track that by default starts at 01:00:00 on the first frame of each CFast media card. It is a sequential code that is continuous from frame to frame and also between clips. Edge Code is equivalent to RUN RECORD as used on broadcast cameras.

For more information, refer to [Secure Format](#).

FORMAT

Use Format to execute a secure format of the media.

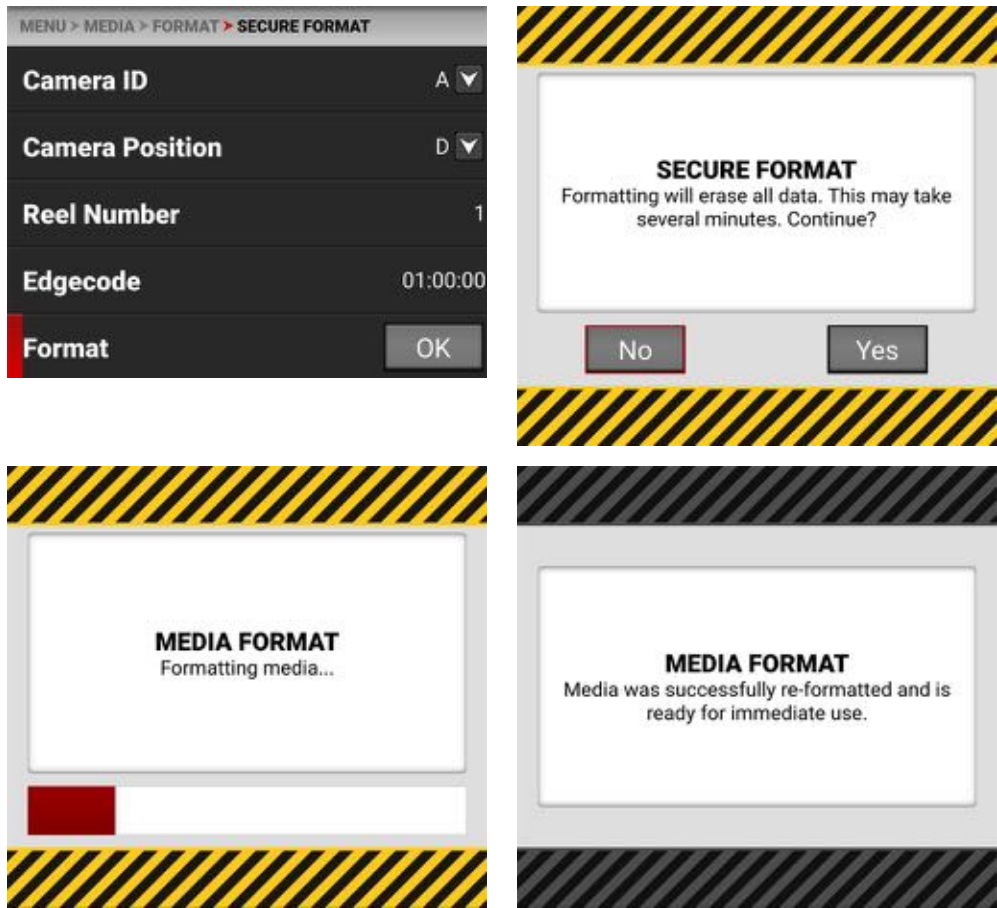

For more information, refer to [Secure Format](#).

AUTOFOCUS - BETA MENU

Use Autofocus to enable and configure the camera's Autofocus feature. The lens must support EF type autofocus for this feature to work.

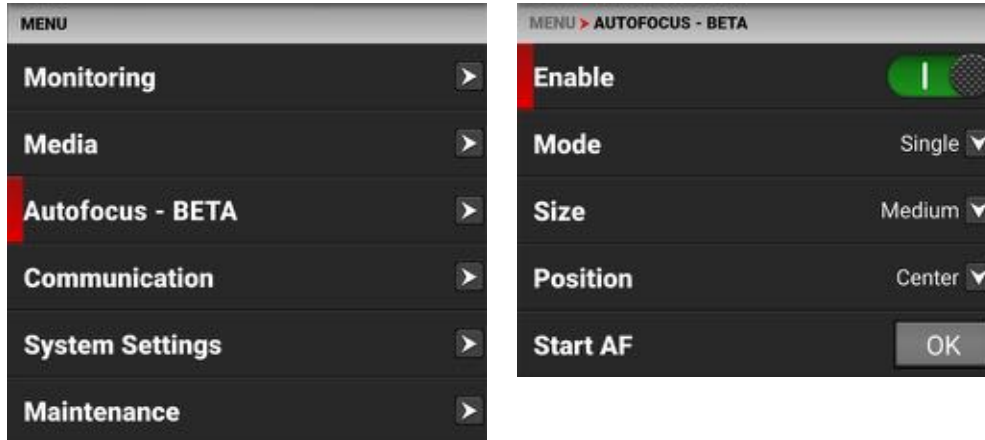

Use the Autofocus menu to perform camera autofocus tasks:

ITEM	DETAILS
Enable	Enable/Disable the autofocus feature
Mode	Select the autofocus mode
Size	Select the size of the autofocus area
Position	Select the position of the autofocus area
Start AF	Button that you tap to start the Autofocus feature

ENABLE

Use Enable to enable or disable the **Autofocus - BETA Menu** feature. The lens must support EF type autofocus for the camera to use this feature.

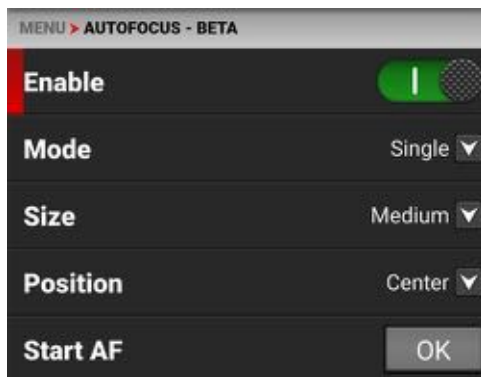

MODE

Use Mode to select the **Autofocus - BETA Menu** mode for the camera. The lens must support EF type autofocus for the camera to use this feature.

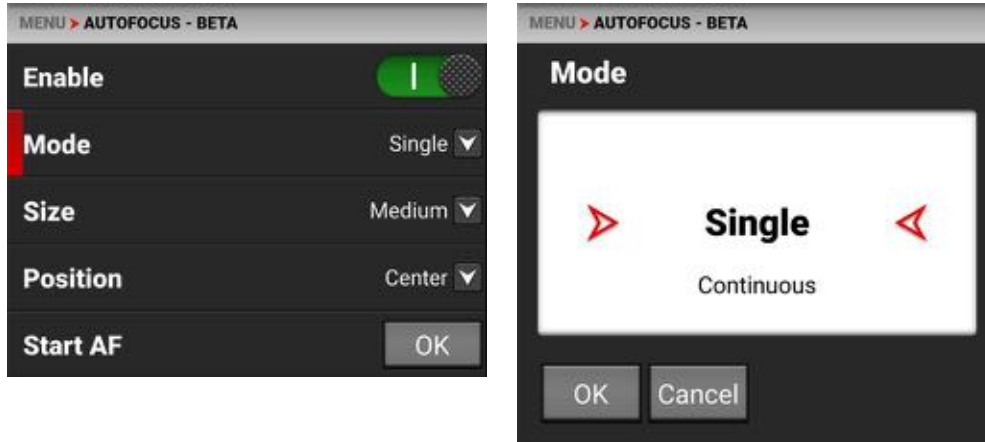

SINGLE MODE

Use single mode to autofocus and then stop at that setting.

CONTINUOUS MODE

Use Continuous mode to continue to change focus to keep a moving subject in focus.

SIZE

Use Size to choose what size area you want the camera to use for the **Autofocus - BETA Menu** feature. The lens must support EF type autofocus for the camera to use this feature.

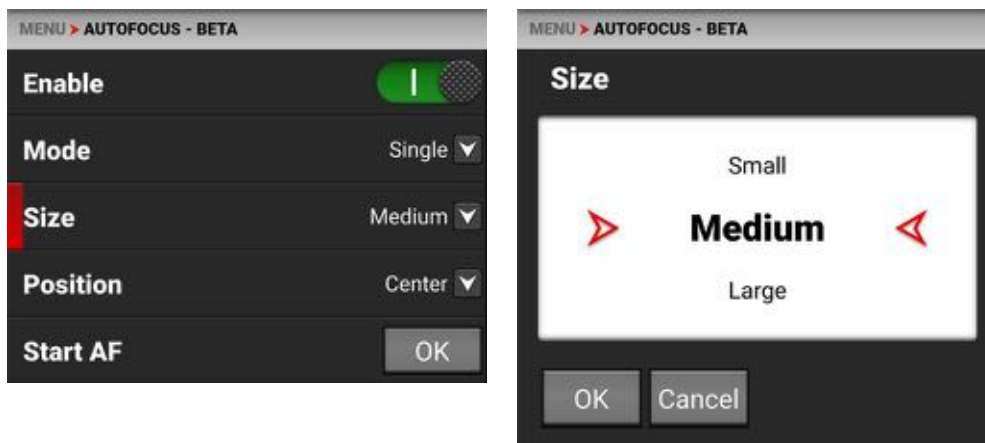

The Size selections for the autofocus area are Small, Medium, Large, Wide, and Vertical.

POSITION

Use Position to specify the position of the **Autofocus - BETA Menu** area on the sensor. The lens must support EF type autofocus for the camera to use this feature.

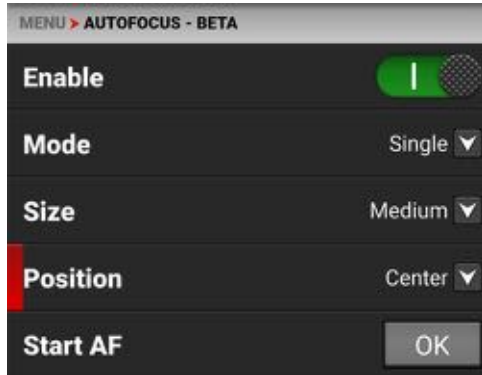

The Position selections include:

- ▶ Left
- ▶ Upper Left
- ▶ Lower Left
- ▶ Center Top
- ▶ Center (default)
- ▶ Center Bottom
- ▶ Top Right
- ▶ Lower Right
- ▶ Right

The Autofocus Position rectangle displays on the screen:



COMMUNICATION MENU

The Communication menu contains the settings you use to configure your camera to communicate with other devices.

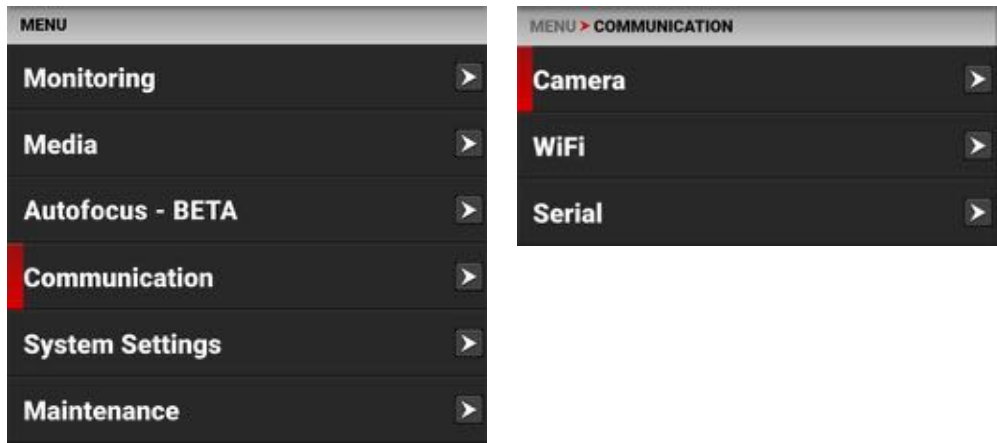

Use the Communication menu to configure the camera's communication settings:

ITEMS	DETAILS
Camera	Setting for the camera name
WiFi	Settings for WiFi communication
Serial	Settings for the Extension Port serial connection

CAMERA

Use the Camera Communication menu to select the camera communication settings.

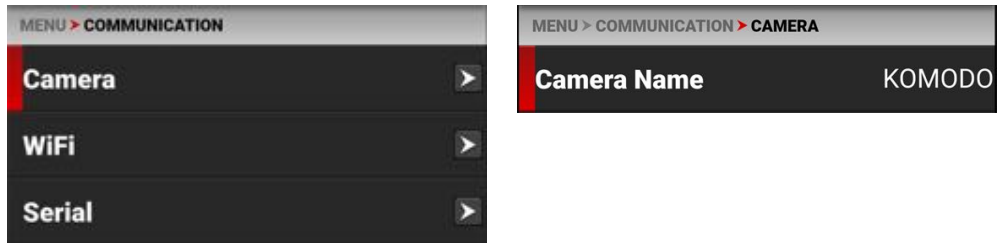

Use the Camera communication settings to configure the camera name.

CAMERA NAME

Use Camera name to enter a camera name.

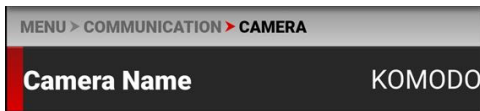

WiFi

Use WiFi to configure the camera to work with a WiFi connection.



Use the WiFi menu to configure the camera's WiFi settings:

ITEMS	DETAILS
Mode	Disable WiFi or select the camera WiFi settings
Ad-Hoc	Configure the camera as a WiFi hot spot
Infrastructure	Settings for existing WiFi infrastructure
MAC	Displays the camera device MAC address

MODE

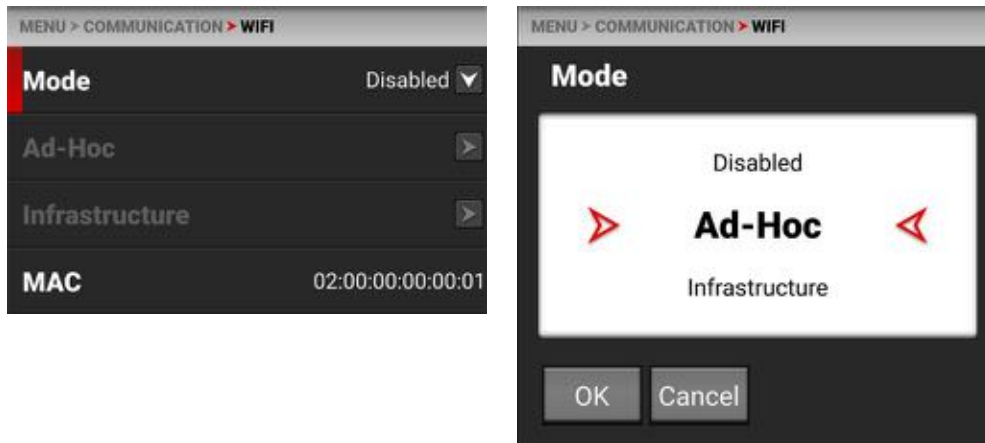

From Mode you can disable the WiFi network, or you can enable the camera's **Ad-Hoc** or **Infrastructure** WiFi settings.

AD-HOC

Use Ad-Hoc to configure the camera as a WiFi hot spot.

NOTE: The Ad-Hoc menu is enabled when the **WiFi** Mode is set to **Ad-Hoc**.

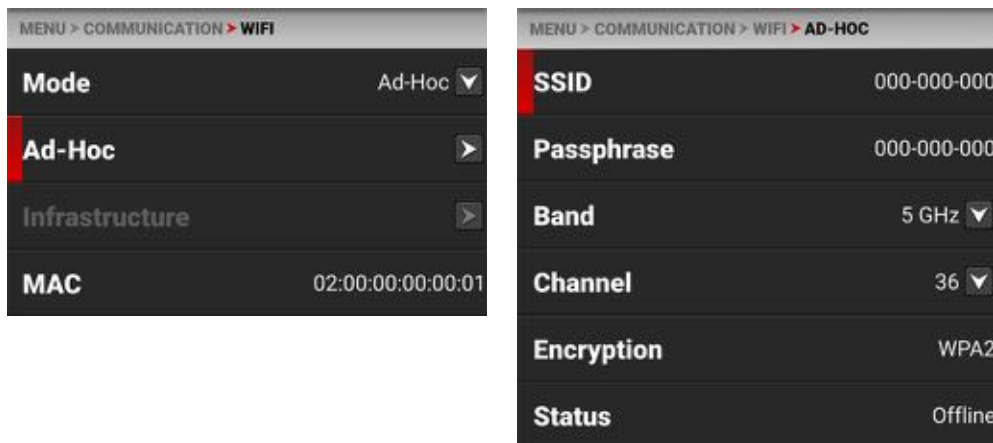

Use the Ad-Hoc menu to configure the WiFi hot spot settings:

ITEMS	DETAILS
SSID	Enter the name of the WiFi network the camera generates
Passphrase	Enter the password for the WiFi network
Band	Select the WiFi frequency band
Channel	Select the optimal channel for the WiFi band
Encryption	Displays the encryption type
Status	Displays the connection status
IP Address	Displays the IP address
Netmask	Displays the Netmask

SSID

MENU > COMMUNICATION > WIFI > AD-HOC	
SSID	000-000-000
Passphrase	000-000-000
Band	5 GHz ▾
Channel	36 ▾
Encryption	WPA2
Status	Offline



Use the keypad to enter the camera's WiFi network name.

PASSPHRASE

MENU > COMMUNICATION > WIFI > AD-HOC	
SSID	000-000-000
Passphrase	000-000-000
Band	5 GHz ▾
Channel	36 ▾
Encryption	WPA2
Status	Offline



Use the keypad to enter the camera's WiFi passphrase.

BAND

MENU > COMMUNICATION > WIFI > AD-HOC	
SSID	000-000-000
Passphrase	000-000-000
Band	5 GHz ▾
Channel	36 ▾
Encryption	WPA2
Status	Offline

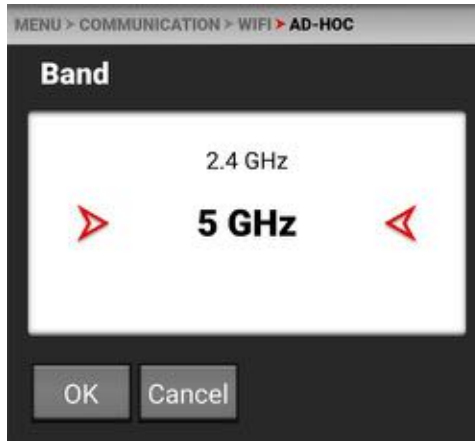

Select the camera's WiFi network frequency band.

- ▶ Use 5 GHz for optimal wireless video streaming performance (default)
- ▶ Use 2.4 GHz for long range remote control (when not utilizing wireless video streaming)

CHANNEL

MENU > COMMUNICATION > WIFI > AD-HOC	
SSID	000-000-000
Passphrase	000-000-000
Band	5 GHz ▾
Channel	36 ▾
Encryption	WPA2
Status	Offline

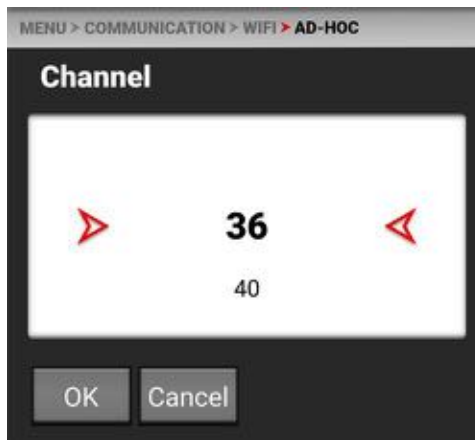

Select the optimal channel for the selected band, one which receives the least interference from the surrounding WiFi signals.

ENCRYPTION

MENU > COMMUNICATION > WIFI > AD-HOC	
SSID	000-000-000
Passphrase	000-000-000
Band	5 GHz ▼
Channel	36 ▼
Encryption	WPA2
Status	Offline

The camera uses WPA2 security encryption.

STATUS

MENU > COMMUNICATION > WIFI > AD-HOC	
Band	5 GHz ▼
Channel	36 ▼
Encryption	WPA2
Status	Offline
IP Address	N/A
Netmask	N/A

Displays the camera's Ad-Hoc WiFi connection status.

The Ad-Hoc status can include:

- ▶ Offline
- ▶ Online

IP ADDRESS

When connected to a network, the camera displays an IP address.

NETMASK

When connected to a network, the camera displays the Netmask for the IP address.

INFRASTRUCTURE

Use Infrastructure to configure the camera to connect to an existing WiFi network.

NOTE: The Infrastructure menu is enabled when the WiFi Mode is set to **Infrastructure**. Refer to the **WiFi** section for more information.

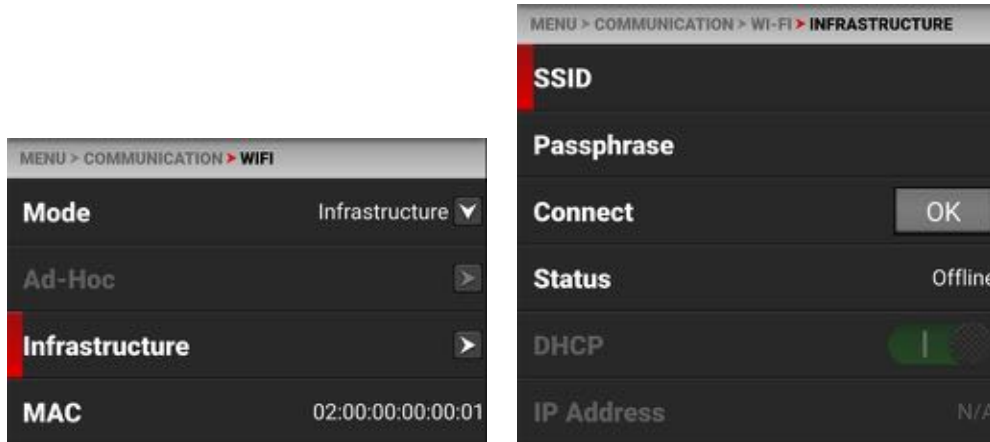

Use the Infrastructure menu to configure the WiFi settings to connect to an existing WiFi infrastructure:

ITEMS	DETAILS
SSID	Enter the name of the WiFi network
Passphrase	Enter the passphrase for the WiFi network
Connect	Button to connect the camera to the configured WiFi
Status	Displays the WiFi connection status
DHCP	Enable or disable DHCP
IP Address	Displays the WiFi IP address
Netmask	Displays the WiFi Netmask
Gateway	Displays the WiFi Gateway

SSID

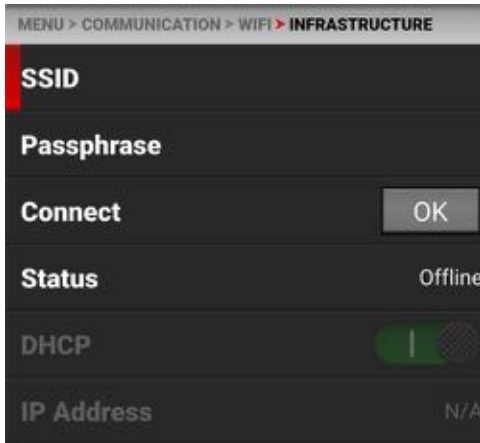

Use the keypad to enter the camera's WiFi network name (SSID).

PASSPHRASE

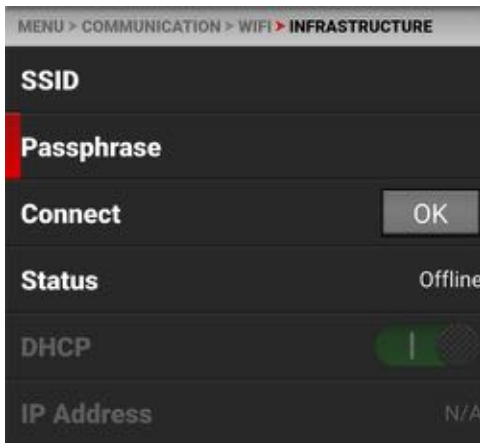

Use the keypad to enter the WiFi infrastructure password. Use the Eye icon to hide the characters or make them visible.



CONNECT

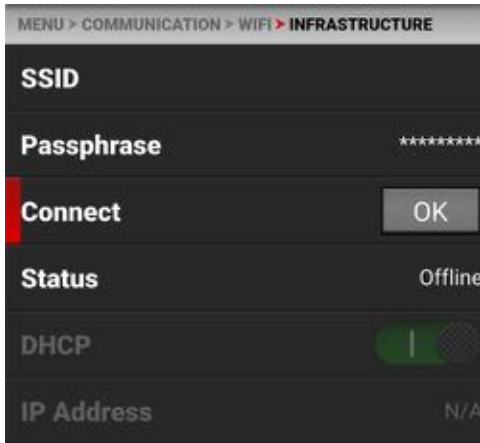

Tap the Connect button to connect the camera to the existing WiFi infrastructure.

STATUS

Displays the connection status of the camera to the WiFi infrastructure.

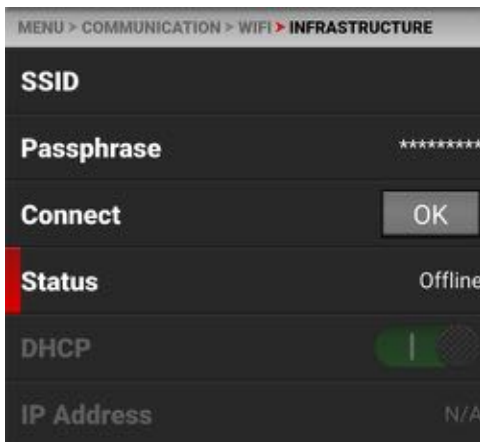

DHCP

When connected to WiFi, this allows you to enable or disable DHCP.

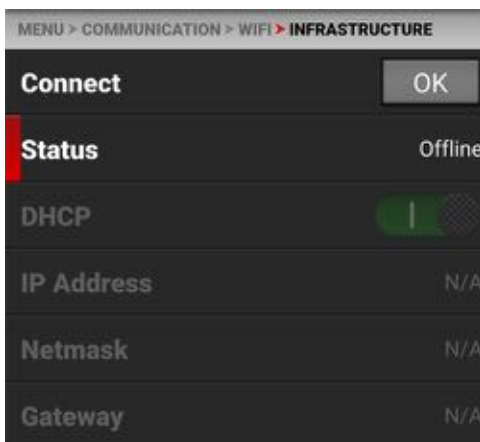

IP ADDRESS

When connected to WiFi, this displays the IP address.

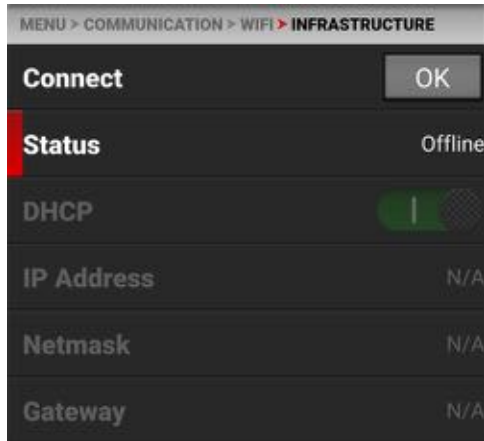

NETMASK

When connected to WiFi, this displays the Netmask.

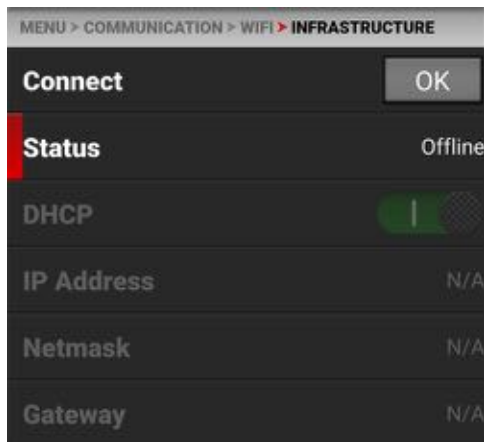

GATEWAY

When connected to WiFi, this displays the Gateway.

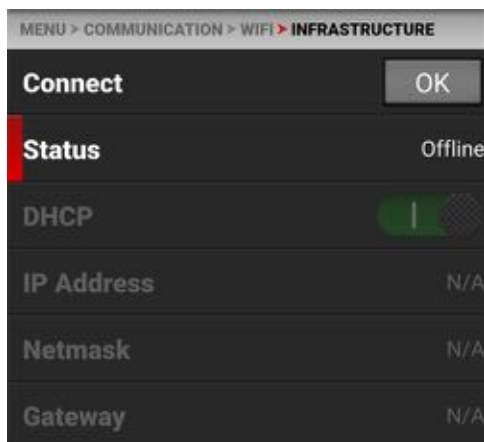

SERIAL

Use Serial to configure the serial connection to the **Extension Port**.



The settings you can configure for the serial connection through the Extension Port include:

ITEMS	DETAILS
Baud Rate	Select the serial port baud rate
IP Address	Enter the IP address for the PPP protocol

BAUD RATE

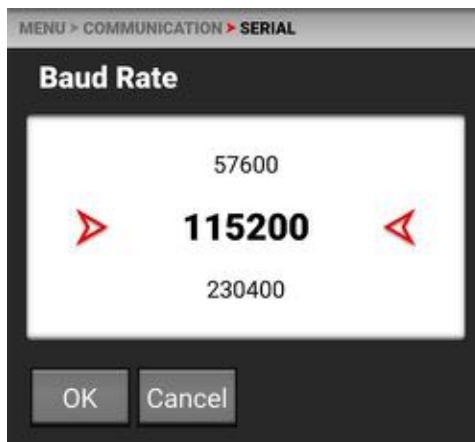
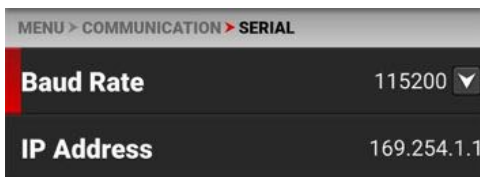

The Baud rate controls how fast data is transmitted over the serial connection. The higher the speed, the more likely that errors can occur. The Baud rates you can choose include:

BAUD RATES			
9600	115200	576000	1500000
19200	230400	921600	2000000
38400	460800	1000000	2500000
57600	500000	1152000	3000000

IP ADDRESS

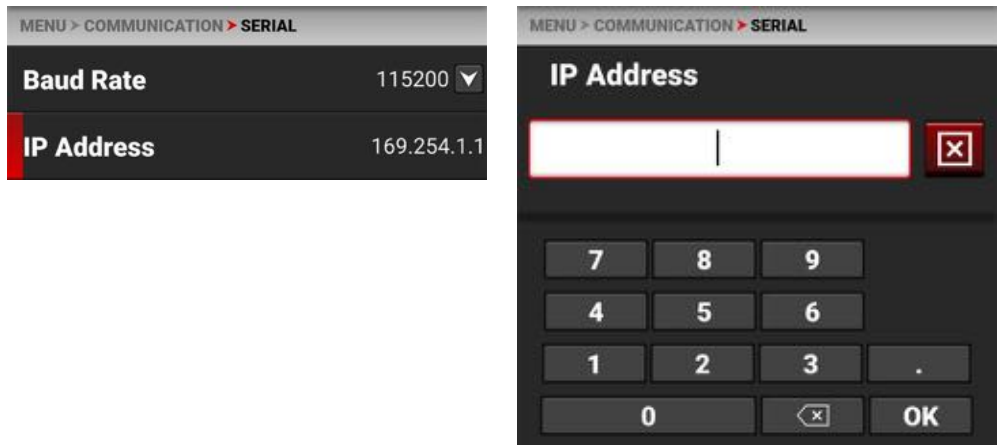

Use the keypad to enter the internet provider's IP address.

SYSTEM SETTINGS MENU

The System Settings menu contains the camera system configuration settings.

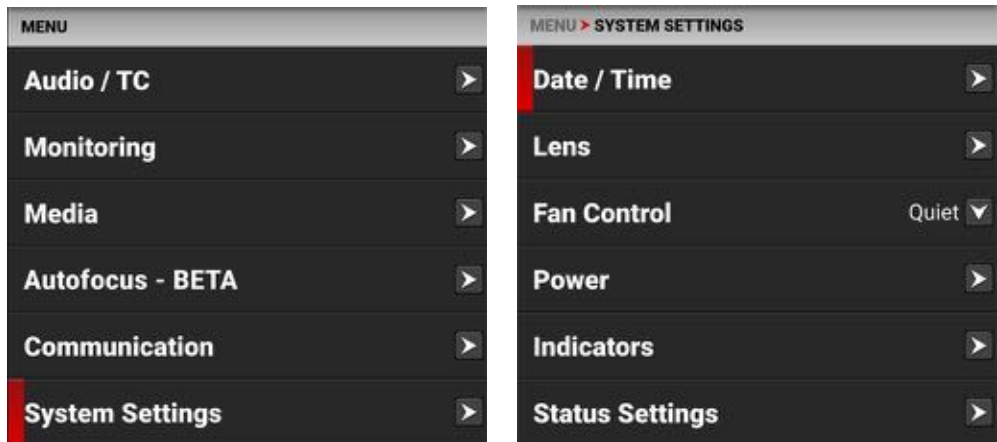

Use the System Settings menu to configure the camera system settings:

ITEMS	DETAILS
Date/Time	Date and time settings
Lens	View lens status information and access the Aperture menu
Fan Control	Adaptive and Quiet fan settings
Power	DC and Battery status
Indicators	Enable or disable the camera's front Tally LED
Status Settings	Shutter mode, Aperture increments, and Focus length units settings
System Status	Information about the camera's type, PIN, FW, and temperatures

DATE/TIME

Use the Date/Time menu to reset the internal clock of the camera. The time and date are timestamped on R3D® files when recording to the media. The camera uses the 24-hour clock convention (military time). For example, enter 2:35 p.m. as 14:35:00.

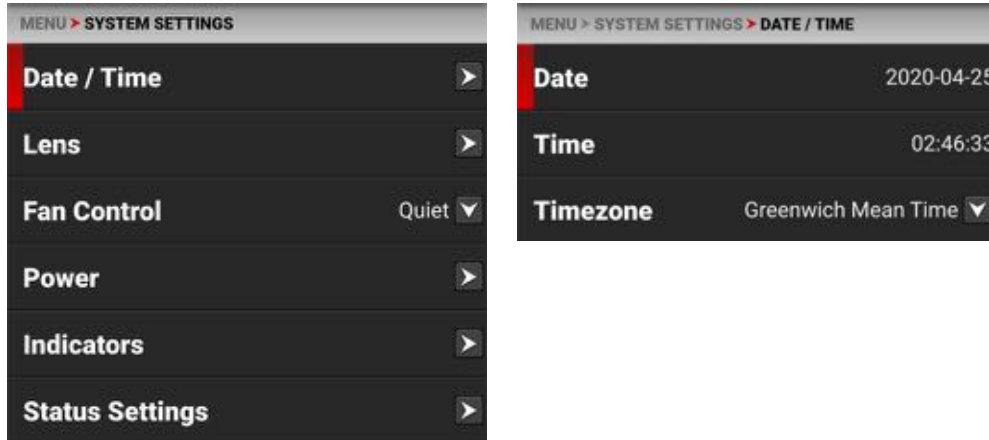

The Date / Time menu items include:

ITEMS	DETAILS
Date	Date in YYYY-MM-DD format
Time	24-hour format
Timezone	Global time zones

DATE

Use Date to enter the date using the touchscreen keypad:

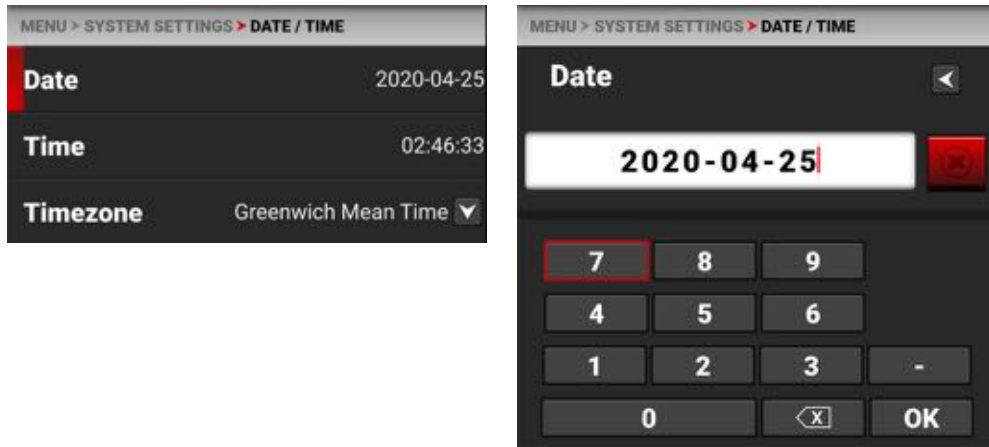

TIME

Use Time to enter the time in 24 hour military format using the touchscreen keypad:

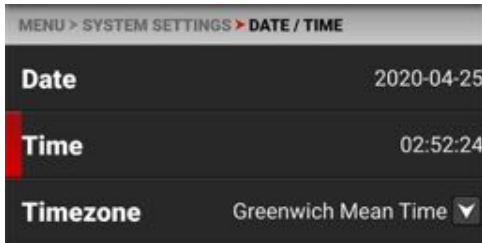

TIMEZONE

Use Timezone to select the local timezone for where the camera is located.

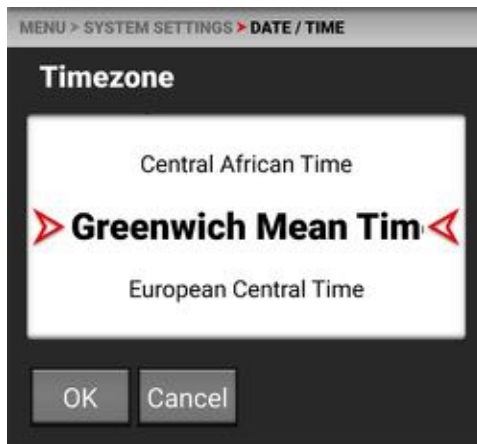
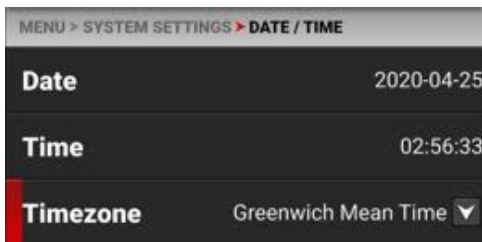

LENS

Use Lens to view information about the attached lens.

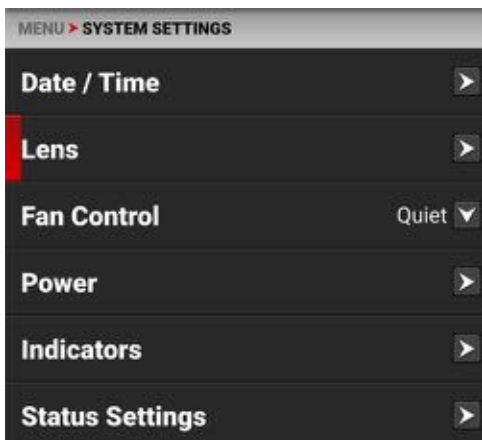

The information you can view from Lens includes:

ITEMS	DETAILS
Focal Length	Displays the lens focal length value
Focus Distance	Displays the lens focal distance value
Iris	Lens Iris menu
Image Stabilization	Displays the lens image stabilization status

IRIS

Use the Iris menu to select the camera lens f-stop.

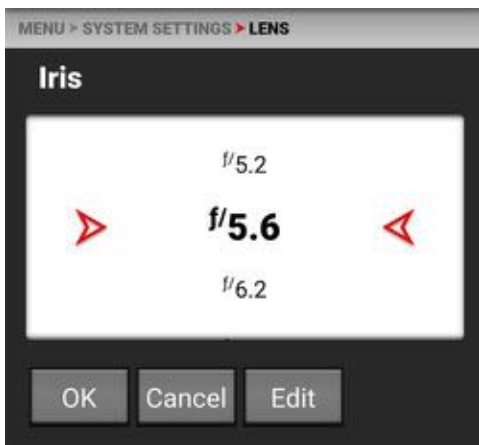

Tap Edit to open the keypad and enter the f-stop manually.

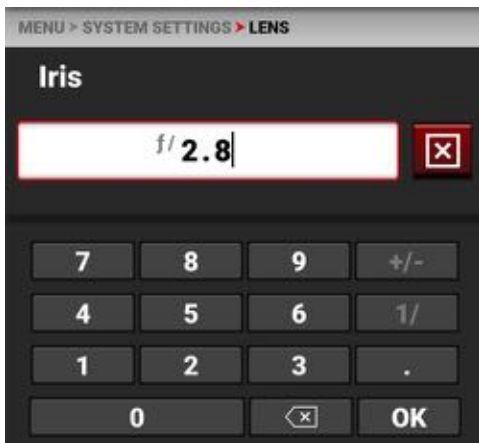

FAN CONTROL

Use Fan Control to configure the camera cooling fan mode:

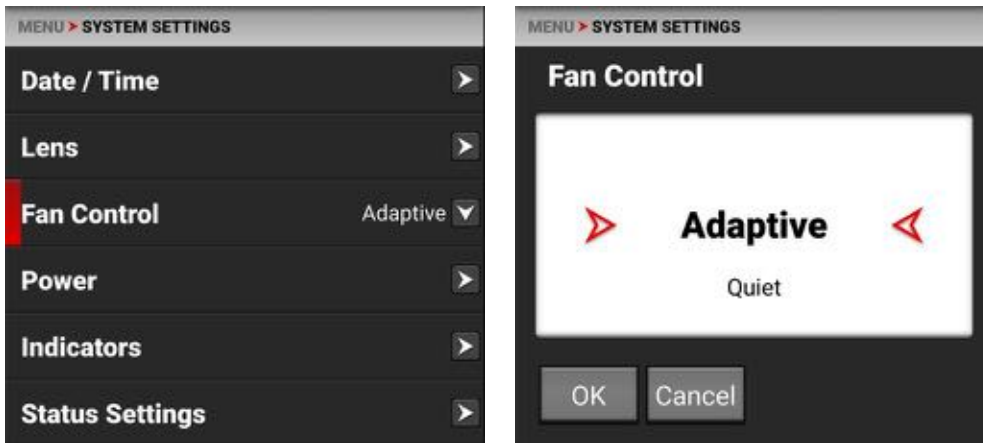

The Fan Control settings include:

ITEMS	DETAILS
Adaptive	The camera changes fan speed according to conditions
Quiet	The fan runs at a quiet speed (default)

The camera is controlled by complex thermal algorithms to ensure that the sensor and camera operate at safe temperatures. Each fan control setting changes the sensor temperature, sensor warm-up time, fan speed, and resulting fan noise.

Regardless of the fan setting you select, you will get the best image quality by calibrating the sensor at the temperature of your shoot.

In quiet mode, the fans self-adjust to maintain the lowest possible noise level while still cooling the camera.

NOTE: After selecting a new fan setting, run the camera until the core temperature stabilizes, and then calibrate the sensor.

POWER

Use the Power menu to view the various camera power status indicators:

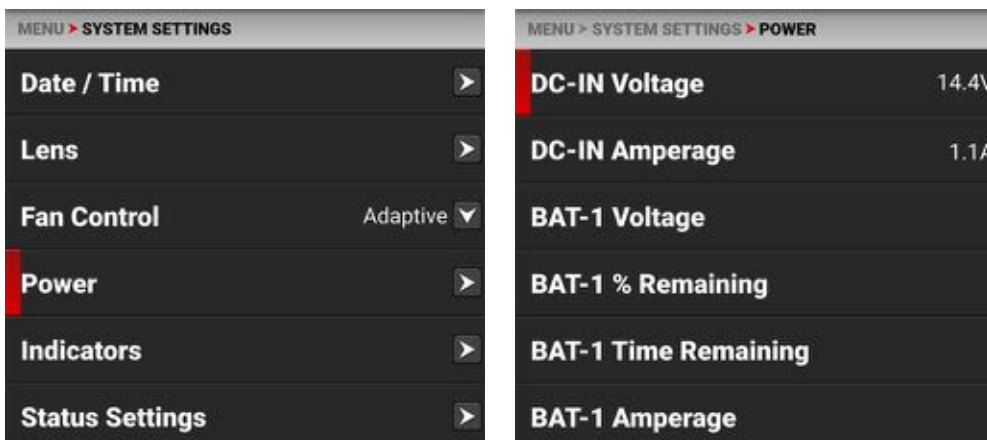

The Power indicators you can view include:

ITEMS	DETAILS
DC-IN Voltage	When DC is connected, this displays the DC Voltage
DC-IN Amperage	When DC is connected, this displays the DC Amps
BAT-1 Voltage	When a battery is connected in the left #1 slot, this displays the battery Voltage
BAT-1 % Remaining	When a battery is connected in the left #1 slot, this displays the % of battery charge remaining
BAT-1 Time Remaining	When a battery is connected in the left #1 slot, this displays the camera operating time remaining
BAT-1 Amperage	When a battery is connected in the left #1 slot, this displays the battery Amps
BAT-2 Voltage	When a battery is connected in the right #2 slot, this displays the battery Voltage
BAT-2 % Remaining	When a battery is connected in the right #2 slot, this displays the % of battery charge remaining
BAT-2 Time Remaining	When a battery is connected in the right #2 slot, this displays the camera operating time remaining
BAT-2 Amperage	When a battery is connected in the right #2 slot, this displays the battery Amps
Power Out	Enables or disables the 5 Volt power out of the Extension Port

INDICATORS

Use the Indicators menu to enable or disable the tally light (refer to the **Camera Body** section for more information about the camera LEDs).

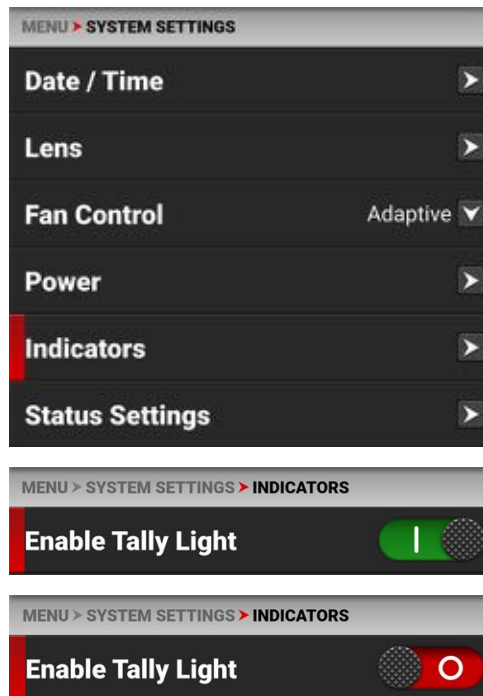

STATUS SETTINGS

Use the Status Settings menu to select the shutter display mode, aperture increment, and focus distance units displayed in the camera's menus.

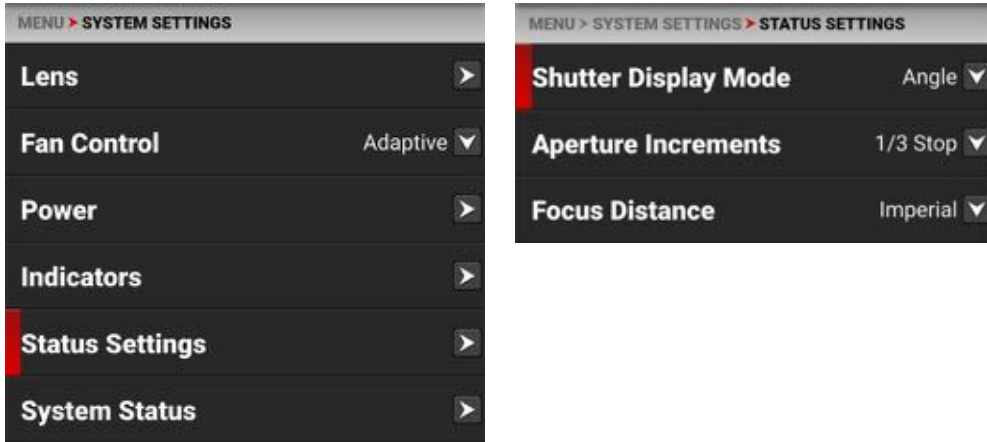

The Status Settings that you can configure include:

ITEMS	DETAILS
Shutter Display Mode	Select a time-fraction or an angle for the shutter menu display unit
Aperture Increments	Select 1/4 or 1/3 f-stop increments
Focus Distance	Select the focus distance units (Metric or Imperial)

SHUTTER DISPLAY MODE

Use Shutter Display mode to select the way that the camera displays the **Shutter** setting in the menu.

When select Angle, the **Shutter** menu displays the choices in degrees. When you select Time, the Shutter menu displays the choices in fractions of a second.

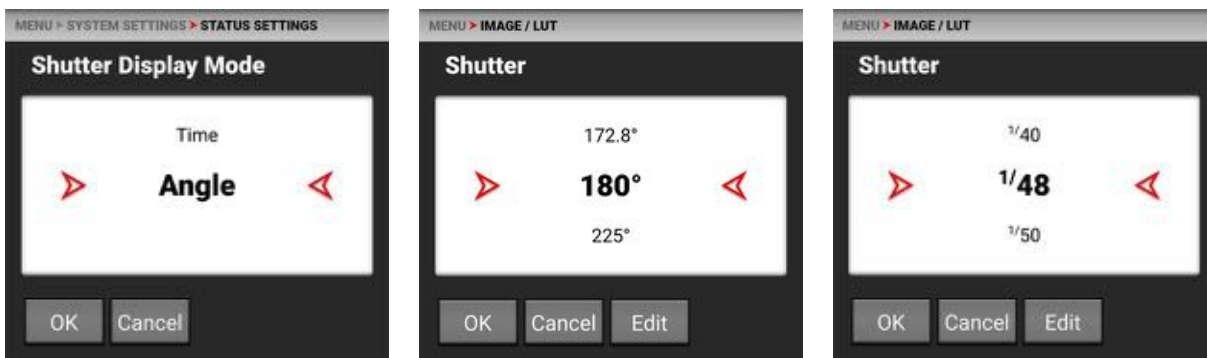

APERTURE INCREMENTS

Use Aperture Increments to select one fourth increments or one third increments for the camera f-stop settings. The default is 1/3 Stop.



FOCUS DISTANCE

Use Focus Distance to select Imperial or Metric units for the **Lens** Focus Distance display. The default is Imperial.

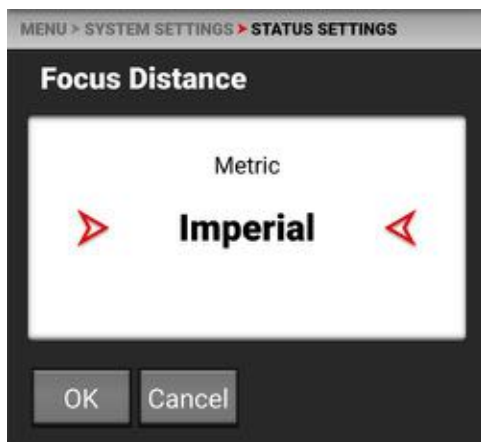

SYSTEM STATUS

Use the System Status menu to view camera information and to view temperature readings.

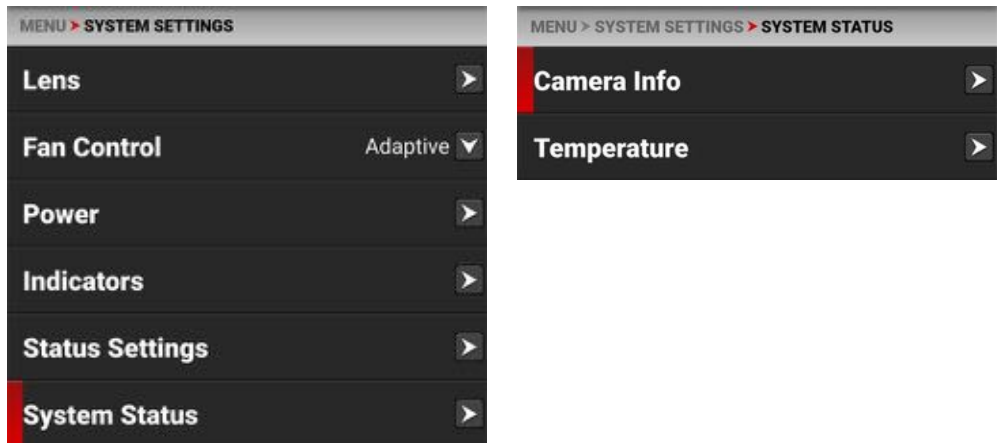

The system status information you can view includes:

ITEMS	DETAILS
Camera Info	Camera information
Temperature	Camera temperatures

CAMERA INFO

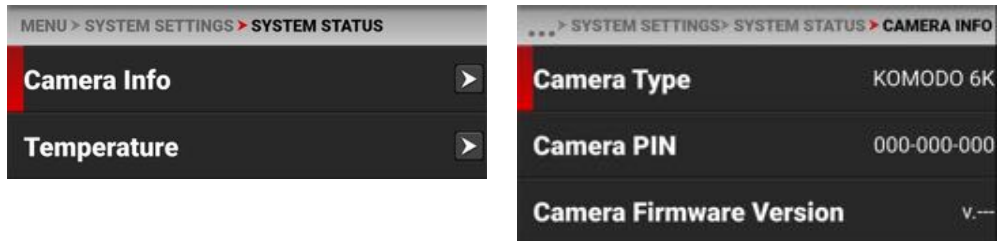

The camera information you can view includes:

ITEMS	DETAILS
Camera Type	Displays the camera description
Camera PIN	Displays the camera personal identification number (PIN)
Camera FW Version	Displays the firmware version number installed on the camera

TEMPERATURE

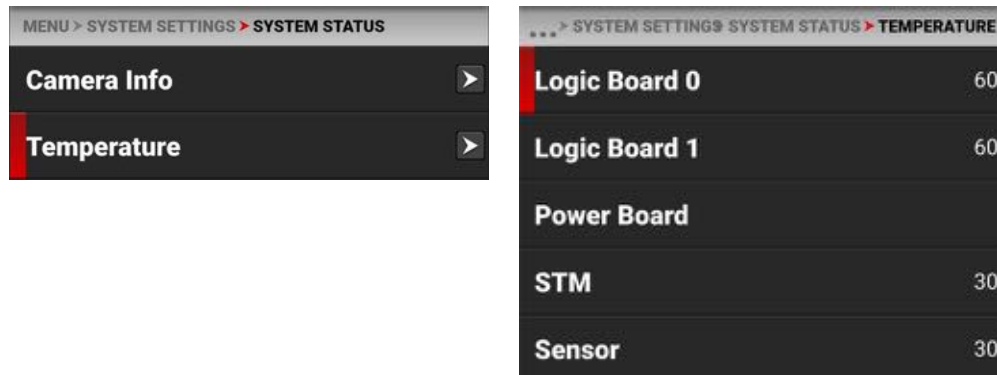

The camera temperatures you can view include:

ITEMS	DETAILS
Logic Board 0	Displays the Celsius temperature of Logic Board 0
Logic Board 1	Displays the Celsius temperature of Logic Board 1
Power Board	Displays the Celsius temperature of the power IC board
STM	Displays the Celsius temperature of the power STM IC
Sensor	Displays the Celsius temperature of the sensor

MAINTENANCE MENU

The Maintenance menu contains the settings you use to perform various maintenance tasks on your camera.

From the camera LCD touchscreen menu, select Maintenance:

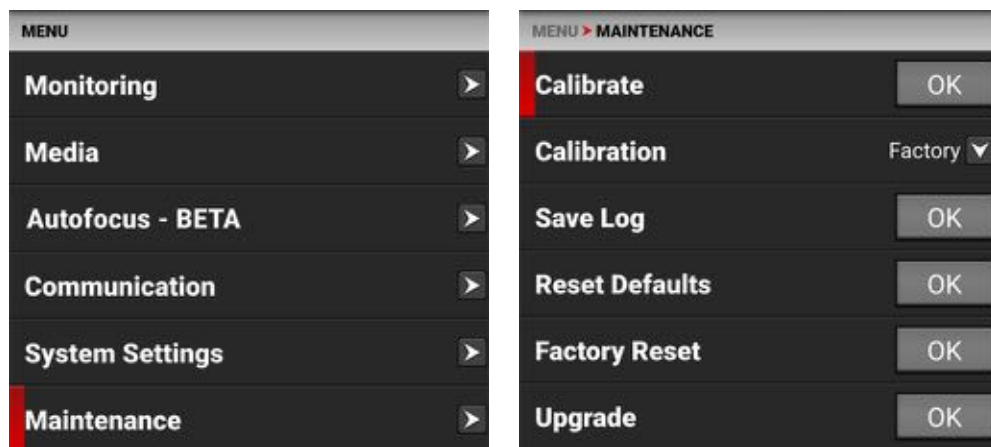

Use the Maintenance menu to perform the following camera maintenance tasks:

ITEM	DETAILS
Calibrate	Performs the selected Calibration
Calibration	List of calibration options
Save Log	Saves the camera log files to the media
Reset Defaults	Resets the camera settings to their default settings
Factory Reset	Restores the camera to the factory settings
Upgrade	Updates the firmware

CALIBRATE

Use Calibrate to start the camera calibration process. Only calibrate the camera after it reaches the filming environment's ambient temperature.

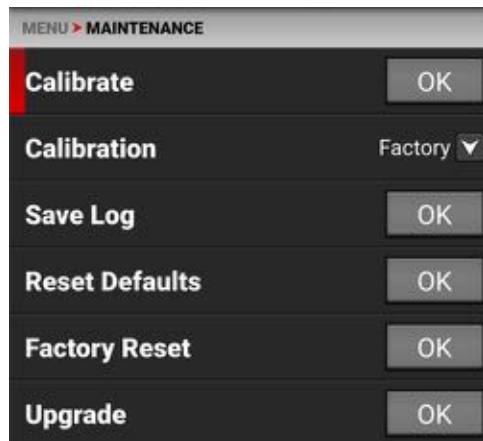

NOTE: Make sure that the mount cap is installed on the camera before you calibrate the camera.

Tap OK on the touchscreen to begin calibrating the camera.

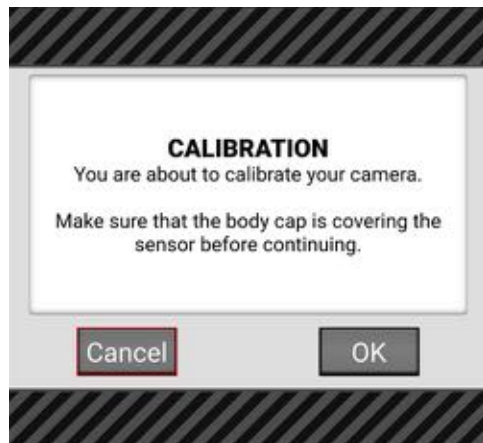

When the camera is finished calibrating, the touchscreen displays the Calibration status message:

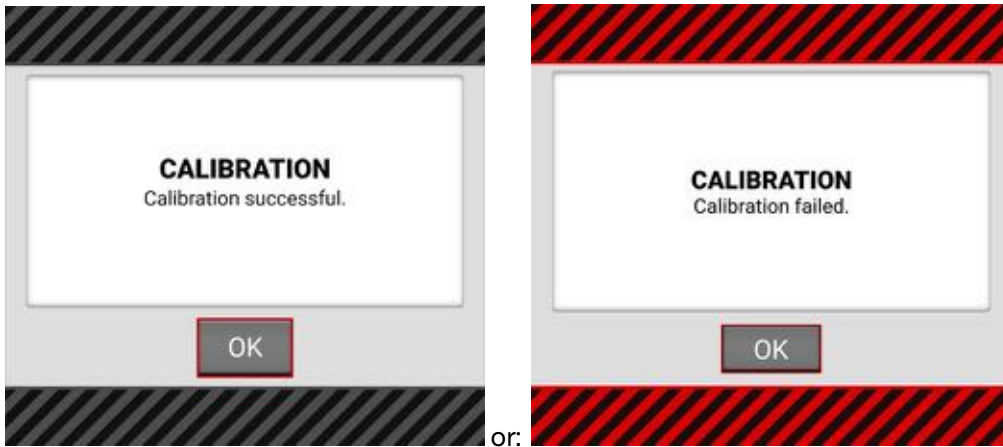

CALIBRATION

Use Calibration to select the camera calibration process you want to perform.

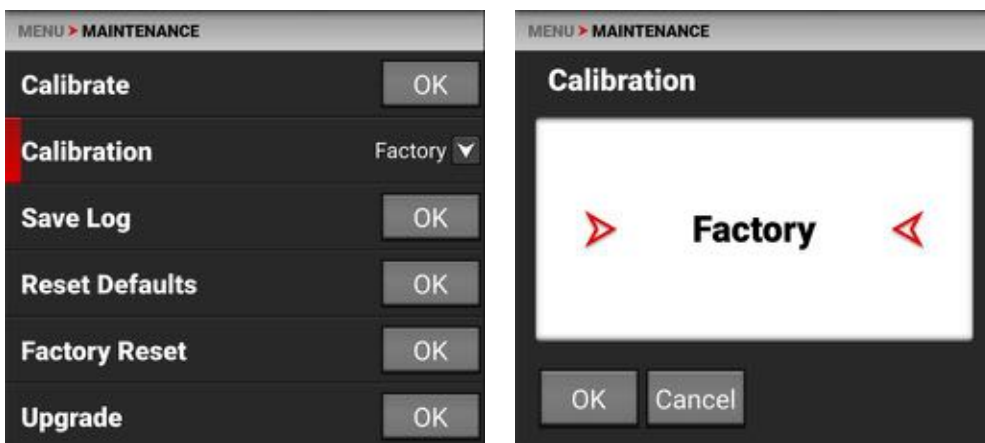

The Calibration type you select here is the calibration type the camera performs when you **Calibrate**.

SAVE LOG

Use Save Log to save the camera log to the media.

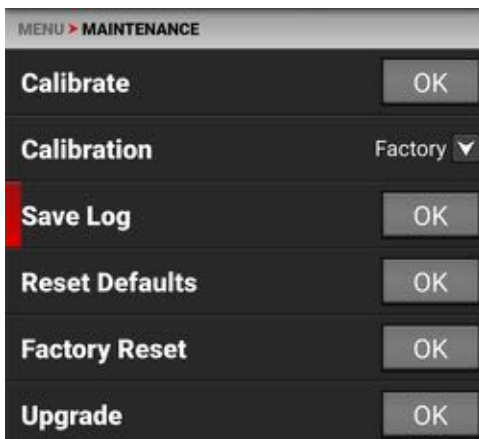

When the media is full, or missing, the camera will display an error message.

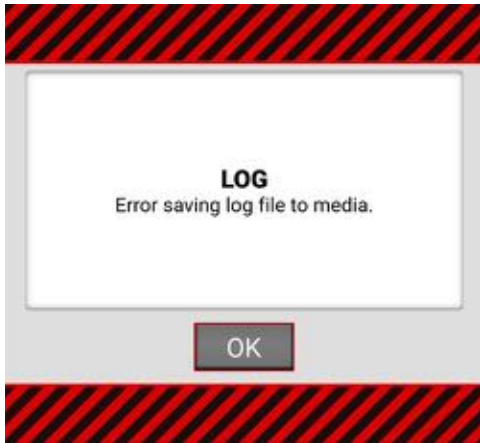

RESET DEFAULTS

Use Reset Defaults to reset the camera to the factory default settings.

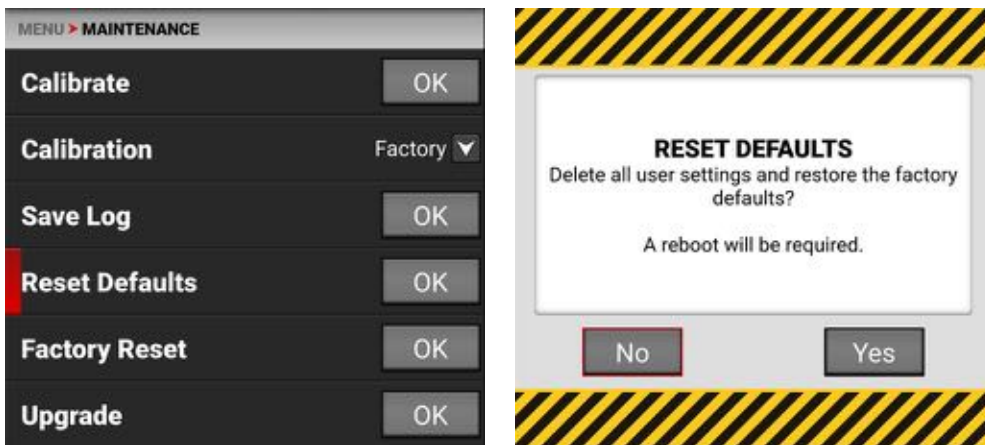

NOTE: Resetting the camera will delete all of your menu settings.

NOTE: The camera turns off, and then back on to complete the reset process.

Tap Yes on the touchscreen to reset the camera menus to the defaults settings.

FACTORY RESET

Use Factory Reset to reset the camera to the factory settings.

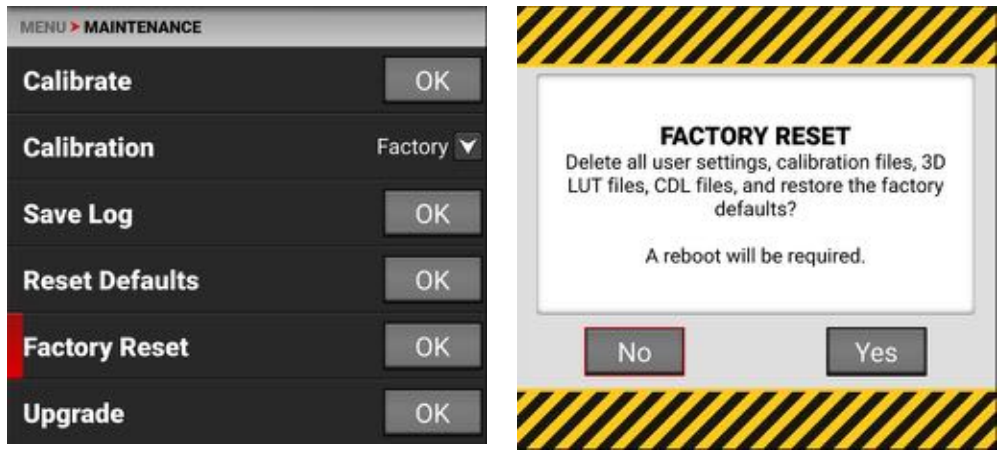

NOTE: Resetting the camera will delete all of your settings and remove all imported files. The camera turns off, and then back on to complete the reset process.

Tap Yes on the touchscreen to reset the camera to the factory settings.

UPGRADE

Use Upgrade to perform a camera firmware update.

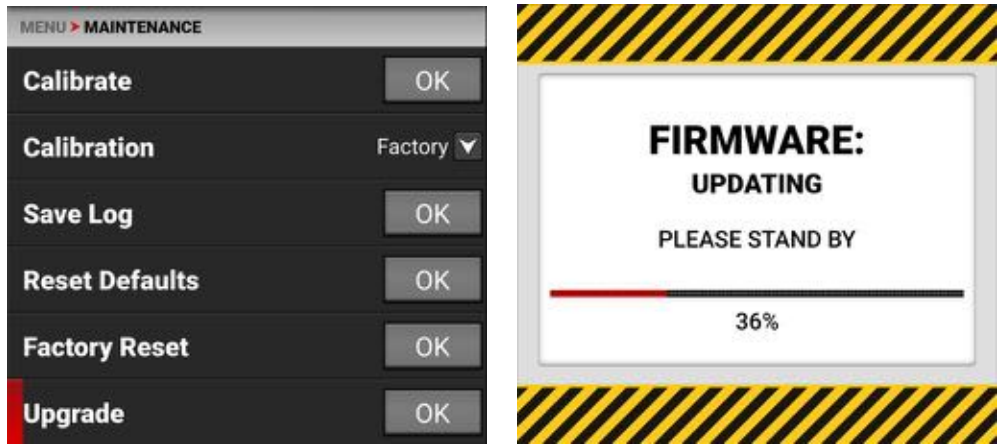

5. HOW TO

This section describes how you can use the camera features.

WIFI CONFIGURATION

The camera offers a wireless (802.11g) connection that provides communication support for third-party applications. As with all wireless devices, the communication range varies with the environment and any radio frequency (RF) interference that may be present. You can select a wireless frequency of 2.4 GHz or 5 GHz. For optimal performance, do not obstruct the antenna with any accessory, mounting plate, or mounting rail.

The camera uses **Ad-Hoc** mode to set up the camera as a WiFi hot spot.

The camera uses **Infrastructure** mode to connect to existing WiFi infrastructure.

CONNECTING WIRELESSLY TO A DEVICE

This camera uses the WPA2 WiFi protocol.

1. Navigate to the WiFi menu **MENU > COMMUNICATION > WIFI**.



2. From the Mode option, select Infrastructure.



3. From the Infrastructure option, enter the SSID.

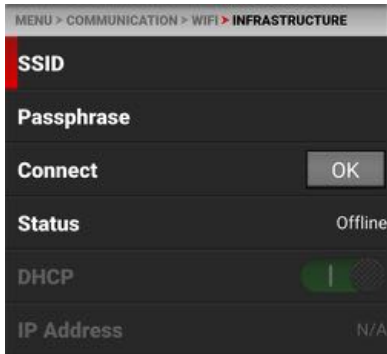

4. Enter the Passphrase (8 characters minimum).



5. Tap the Connect OK button.

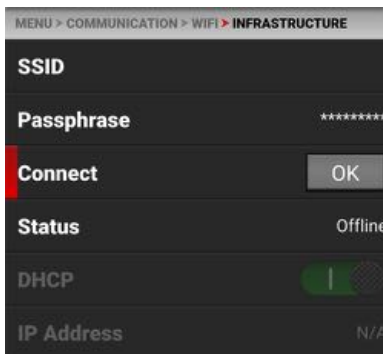

The camera connects to the WiFi infrastructure.

POWER

ATTACHING THE BATTERIES

Insert at least one compatible battery (refer to [Batteries](#)) in one of the two battery slots. Slide the battery until it clicks.



The camera can charge the batteries when they are attached to the camera and the DC power Adaptor is connected. The camera charges the batteries only when the camera is off and the power Adaptor is connected. Recharging two batteries takes approximately eight hours, depending on the battery capacity. While the batteries are charging the DC Power LED will blink amber.

REMOVING THE BATTERIES

You can hot swap a dead battery when you have another charged battery attached, and you can continue recording while you make the swap.

1. While holding the attached battery, press the **Eject Button**.
2. Slide and lift the battery out.

POWER COMPONENTS

You can power the KOMODO camera with the RED [KOMODO Power Adaptor](#), an External DC Power Source, or with the rear-mounted [Batteries](#).

For information about charging, storing, or maintaining the batteries, refer to the manufacturer's instructions.

KOMODO POWER ADAPTOR

The KOMODO 45 Watt AC power Adaptor connects to the camera's **DC-Input** port to provide DC power for operating the camera and for recharging the attached **Batteries**.



The camera charges the batteries when the camera is off and the power Adaptor is connected. Recharging two batteries takes approximately eight hours.

AUTO BOOT ON POWER

The camera supports the Auto Boot on Power feature. This means that if all power sources are removed, and the Power Switch is set to ON, then when a power source is attached, the camera turns on.

POWER CONSUMPTION

The camera draws approximately 37 Watts of power under normal operating conditions.

POWER PRIORITY

When multiple power sources are connected to the camera, power consumption is prioritized in this sequence:

1. Any power supply connected to the DC IN port.
2. Attached battery in the left slot (facing the back of the camera) then the battery attached in the right slot.

TURNING ON THE CAMERA

1. Attach a power source (**Batteries** or **DC-Input**) to the camera.
2. Slide the **Power Switch** up to the **ON** position.



TURNING OFF THE CAMERA

NOTE: The camera stops recording and turns off automatically when the supply voltage drops to 11.5 V.

NOTE: Do not turn off the camera while the camera is recording or formatting media.

Slide the **Power Switch** down to the **OFF** position.



MEDIA MANAGEMENT

This section explains how to use, record, format, and offload media for the camera.

The camera supports exFAT as the file system for the media card to accommodate larger files and data rates. exFAT is supported both on macOS and MS Windows.

EJECTING MEDIA

IMPORTANT: To ensure data integrity, media must always be ejected prior to removal from the camera. This ensures that power is removed from the media and any open data files are closed. Failure to properly eject media may result in lost data or corrupted files.

To eject media from the camera, use the **LCD Touchscreen** and select **Menu > Media**.

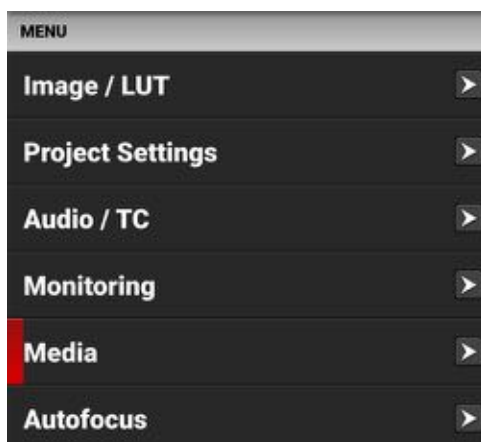

Tap the eject button:



The Success message displays:



The media is now ejected and all media related items are grayed out in the menu.

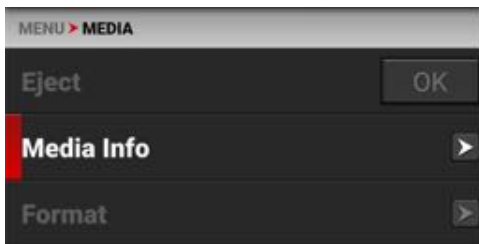

WARNING: The media can get extremely hot. Use caution when removing media.

Removing a CFast media card without ejecting first does not damage the media, however, it does increase the risk of file corruption. It is good practice to eject the media when possible before removing or disconnecting. Ejecting the media provides the following benefits:

- ▶ Protects the integrity of your recorded data
- ▶ Mounts clips instantly to your workstation in post production

NOTE: If you remove media without ejecting first, you receive a warning notification: "Media removed without first ejecting. Data integrity risk." Always eject media before physically removing the CFast media card to protect your media and footage.

INSERTING THE MEDIA

The camera contains a covered compartment on the right side where you insert the CFast media card.



INSERTING THE CFAST MEDIA CARD

1. Slide the media door latch back, and open the media door.



2. Insert the CFast media card in the slot with the top of the card facing toward the front of the camera. Insert the card until it is firmly seated.
3. Close the media door and make sure that the door latch clicks.
4. If needed, format the CFast media card. Refer to [Secure Format](#) for more information.

REMOVING THE CFAST MEDIA CARD

NOTE: Do not remove the CFast card while the camera is recording or formatting media. Refer to [Media Management](#) for more information.

WARNING: The media can get extremely hot. Use caution when removing media.

1. If the camera is on, go to **Menu > Media** and select **Eject**.
2. Slide the media door latch back and open the media door.



3. Press the card eject button above the CFast media card.



4. Let the CFast media card cool before gently pulling the card out of the slot.

WARNING: The media can get extremely hot. Use caution when removing media.

5. Close the media door and make sure that the door latch clicks.

SECURE FORMAT

A secure format is a low level format that rebuilds the CFast card file system. A secure format erases all data on the card.

Perform a secure format when the camera is reporting media-related errors.

PERFORMING A SECURE FORMAT

CAUTION: Ensure all data is backed up before formatting a card. Data erased during formatting cannot be recovered.

WARNING: The media can get extremely hot. Use caution when removing media.

To perform a secure format, follow the instructions below:

1. Go to **MENU > MEDIA > FORMAT > SECURE FORMAT**

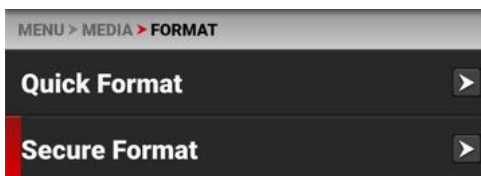

2. From the Secure Format menu, select the desired **Camera ID**, **Camera Position**, **Reel Number** and **Edgecode**. Tap the Format button to start the Secure Format process:

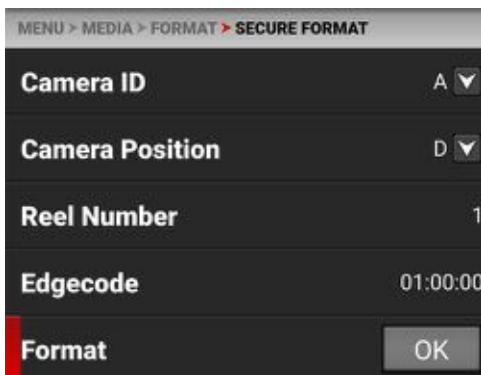

The confirmation message displays:



3. Tap Yes to begin formatting.

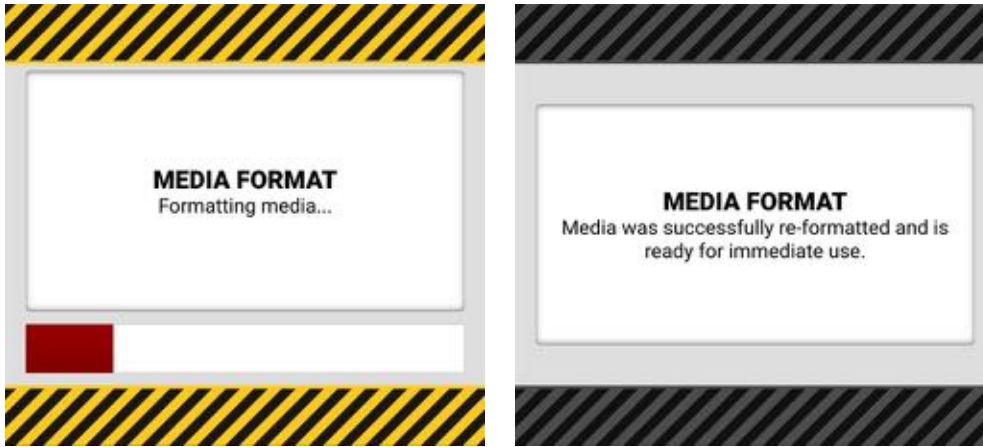

FORMATTING MEDIA ON A COMPUTER

RED recommends that you only format your CFast media card from a computer when you cannot mount the media to the camera.

MEDIA INFORMATION

Use the **Media Info** menu to display the CFast media card information.

Media information includes the following:

SETTING	DETAILS
Status	Displays the CFast media card status
Model Number	Displays the CFast media card model number
Serial Number	Displays the CFast media card serial number
Firmware Version	Displays the CFast media card firmware version
Percentage Remaining	Displays the CFast media card's remaining storage*
Time Remaining	Displays the recording time remaining on the CFast media card*

* with the current project settings

FILE SYSTEM

The KOMODO camera formats the CFast media card using exFAT. Both Mac® and Windows®-based computers support CFast media cards with this format. Refer to the documentation for your operating system to determine whether there are any limitations to its file format support.

CLIP NAMING CONVENTION

When you record a clip, the camera creates a unique name for the clip folder that uses the format described in the table below:

NAME	DESCRIPTION	EXAMPLE
Camera ID	The letter assigned to the camera (refer to Camera ID)	A
Reel ID	The reel number assigned to the media (refer to Reel Number)	004
Clip Number	The letter C followed by three digits starting with 001	C001
Month	Month that the clip is recorded (refer to Date/Time)	12
Day	Day that the clip is recorded (refer to Date/Time)	04
Two Characters	Two random alphanumeric characters generated by the camera to prevent any possibility of duplicates	6M
.RDC	Clip folder extension	.RDC

For example, a sequence of clip folders within a media folder on Camera A may look like this:

- ▶ A001_C001_12046M.RDC
- ▶ A001_C002_1204CE.RDC
- ▶ A001_C003_1204R5.RDC

CLIP METADATA

The following metadata is recorded for each frame of each clip:

- ▶ Audio Data
- ▶ Clip
- ▶ Configuration, Camera Name, Network, Model, Model ID, Serial Number
- ▶ Copyright
- ▶ Date and GMT
- ▶ Filename
- ▶ Firmware Version
- ▶ Frame Guides
- ▶ HDR Mode
- ▶ Jamsync Setting
- ▶ Lens and Shutter Speed/Angle Parameters
- ▶ Lens Name, Brand, ID, Near Focus, Far Focus
- ▶ Location
- ▶ LTC User Bits (3 32-bit word reg-dump from ISP)
- ▶ Luma Curve
- ▶ Media Serial Number
- ▶ Production Name
- ▶ REDCODE®
- ▶ Reel
- ▶ RGB Curves
- ▶ Scene
- ▶ Shadow Control
- ▶ Stereo Setup
- ▶ Take
- ▶ Timecode
- ▶ Unit

MEDIA BEST PRACTICES

This section describes best practices to ensure that your CFast cards continue to provide reliable storage and fast data rates. Following these best practices may prevent your CFast card from becoming fragmented, which can lead to data integrity errors.

- ▶ The only files that should be saved from your computer to your CFast card are Preset files, Firmware Upgrade files, and LUTs. DO NOT save other files, folders, or applications to your media.
- ▶ DO NOT back up your hard drive to the CFast card. If using a Mac, the system may ask if you want to back up your files to the CFast card using Time Machine; DO NOT use the CFast card as a backup disk.
- ▶ DO NOT delete clips off of your CFast card using a computer. Delete clips only by formatting your CFast card in-camera. For more information about formatting your CFast card, refer to [Secure Format](#).
- ▶ DO NOT format your CFast card using a computer, unless the CFast card cannot mount to the camera. For more information, refer to [Secure Format](#).
- ▶ When ejecting the CFast card from a computer, ensure that the icon has completely disappeared from the Finder window (Mac) or from Windows Explorer (Windows) before removing the CFast card. Sometimes, the pop-up saying that the CFast card has ejected displays too early.

INDEXING ON A MAC

Most newer versions of the Mac OS automatically index all external drives when mounting them, including CFast cards. Indexing makes the mounting process take longer. While the CFast card mounts, DO NOT remove the card.

Indexing writes hidden files to the CFast card. When you mount the CFast card to the camera after it has been indexed, it may take the camera a while to recognize the hidden files and mount the CFast card. While the CFast card mounts, DO NOT remove the CFast card or turn off the camera during this process. After the CFast card successfully mounts, perform a secure format to remove the hidden files. For more information, refer to [Secure Format](#).

EXPOSURE

The camera offers multiple tools to determine the current image exposure levels and provides the tools to adjust the exposure to the desired levels.

When using the R3D file format, you can correct color temperature and ISO settings at any time. The aperture and exposure time however, are two of the parameters that you cannot corrected later in R3D files.

NOTE: ProRes file format burns in all of the settings and does not allow later corrections to the recorded image.

While the correct exposure is always an artistic decision, there are best practices for creating the most dynamic range while allowing post production to preserve the intended image information.

The goal is to reduce clipping in the bright and dark parts of the image as much as possible. Otherwise the sensor information is lost in the overexposed and underexposed areas.

The primary tool for determining the exposure levels is the histogram. It shows exactly what the sensor is detecting. Monitors have their own color gamuts and brightness levels which makes the monitor less than optimal for determining the camera's exposure levels.

This camera includes a full [Histogram](#) that can toggle to a simple indicator that only shows the sensor 's RGB levels and it signals when these levels are clipping in the light and dark areas.

The full histogram provides information about how the brightness is distributed in the image. This allows you to see how close a scene is to clipping in the light and dark areas, which makes it easy to choose aperture, exposure, and ND filters solutions accordingly.

EXAMPLE OF OVEREXPOSURE WITH HISTOGRAM:



EXAMPLE OF UNDEREXPOSURE WITH HISTOGRAM:



EXAMPLE OF A BALANCED EXPOSURE WITH HISTOGRAM:



FALSE COLOR EXPOSURE TOOLS

While the histogram provides information about the brightness distribution and clipping of the image, it does not show you the areas in the image that are near, or that have reached, clipping. For this, the camera provides image overlays that provide false colors to indicate precise exposure levels.

FALSE COLOR EXPOSURE MODE

The False Color Exposure mode overlay provides information where the image is close to clipping or already clipping in the highlights (red) and low-lights (green) (refer to [False Color Exposure Mode](#)).

EXAMPLE OF OVEREXPOSURE WITH EXPOSURE MODE:



EXAMPLE OF BALANCED EXPOSURE WITH EXPOSURE MODE:



FALSE COLOR VIDEO MODE

The False Color Video mode provides more gradual information about the brightness in different parts of the image. This is helpful when you want to expose skin color at the right level, while ignoring the fact that backgrounds might be overexposed or underexposed (refer to [False Color Video Mode](#)).

EXAMPLE OF OVEREXPOSURE WITH VIDEO MODE:

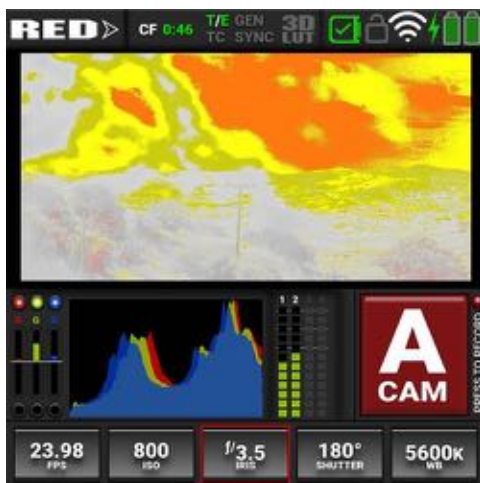

EXAMPLE OF BALANCED EXPOSURE WITH VIDEO MODE:

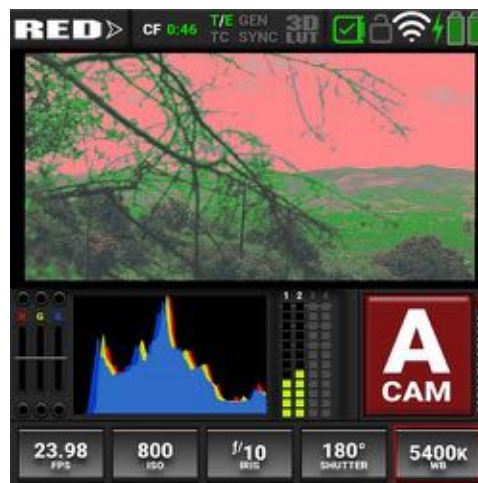

FOCUS

Focus, like **Exposure** and **Recording Frame Rate** is a property that cannot be fixed easily in post-production. To make sure the camera is focused correctly when you begin recording, it is important to rely on focus tools that do not rely on the visibility on the LCD Touchscreen or a monitor.

The camera interface includes the focus tools you can use to reach the desired image focus (refer to **Peaking**).

FOCUS PEAKING MODE

The Focus Peaking mode applies a sharpening filter to the image that emphasizes edges of the subject in focus.

EXAMPLE OF FOCUS PEAKING MODE ON A NEAR SUBJECT:



EDGE PEAKING MODE

The Edge Peaking mode hides the image and only show the edges. This provides the best visual representation of the subject that is currently in focus.

EXAMPLE OF EDGE PEAKING MODE ON A NEAR SUBJECT:



EXAMPLE OF EDGE PEAKING MODE ON A FAR SUBJECT:



PEAKING PEAKING MODE

The Peaking Peaking mode emphasizes the edges, and it also highlights them by using a selectable color.

EXAMPLE OF PEAKING PEAKING MODE ON A NEAR SUBJECT:

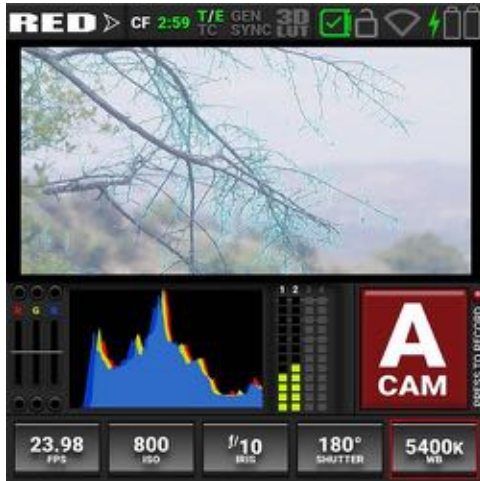

EXAMPLE OF PEAKING PEAKING MODE ON A FAR SUBJECT:



TIMECODE

Timecode provides a mechanism to reference frames from the camera's recorded clips to other devices like cameras and audio recorders. Some devices can also gather other data like lens metadata or camera orientation that is referenced by Timecode to merge the data back together in post-processing.

KOMODO provides two separate Timecode concepts: Time of Day (TOD) and Edgecode. Both TOD and Edgecode are stored in the R3D file. The user can select which Timecode displays on the **LCD Touchscreen** by setting the preference in **Timecode Display Mode**.

TIME OF DAY

TOD Timecode reflects the time and date the camera recorded each frame. KOMODO synchronizes the TOD Timecode to an external Timecode generator (when one is connected to the **Extension Port**) or synchronizes to the internal real-time clock of the camera.

SETTING UP TOD TIMECODE

To set up TOD Timecode on the camera, perform the following:

1. Open the Audio / Timecode menu: **MENU > AUDIO / TC:**

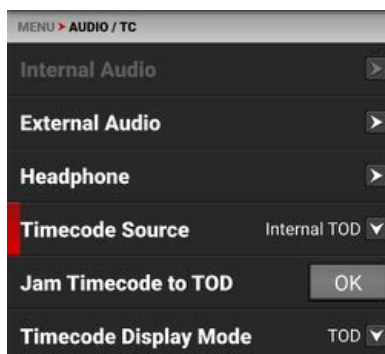

2. Select Timecode Source. The Timecode Source menu opens:



3. Select Internal TOD to use the camera's internal real time clock, or select External to use an external Timecode generator connected to the **Extension Port**.
4. When you select Internal TOD, you can use the **JAM Timecode to TOD** button to synchronize the Timecode to the camera's internal clock.

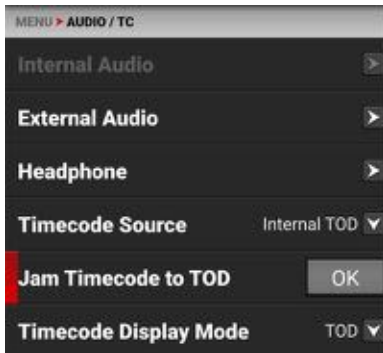

The camera displays the Timecode on the **LCD Touchscreen**



NOTE: The timecode is reset when the camera is turned off, unless an external power source remains connected and powered.

EDGECODE

Edgecode only advances while the camera is recording frames. Each frame is sequential. When the media is replaced, the new media starts the timer over. You can set the Edgecode timer manually by using the **Secure Format** menu.

SETTING UP EDGECODE TIMECODE

To set up Edgecode Timecode on the camera, perform the following:

1. Open the Audio / Timecode menu: **MENU > AUDIO / TC:**

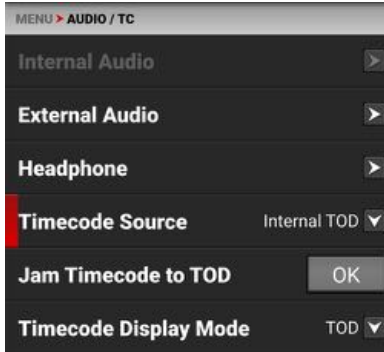

2. Swipe the touchscreen up to scroll down to Timecode Display Mode:

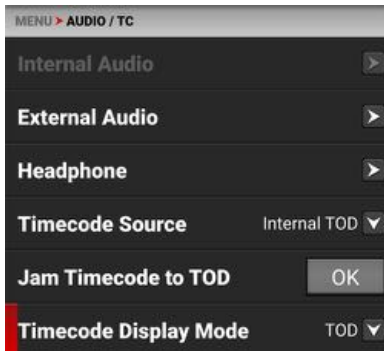

3. Select Timecode Display Mode. The Timecode Display Mode menu opens:



4. Tap OK to select Edge to use Edgecode. The camera displays the Edgecode on the **LCD Touchscreen**



ZEBRA MODES

Use Zebra mode to enable and adjust the upper and lower values for two (2) independent zebra indicators. Use Zebra 1 for highlight exposure, and use Zebra 2 for mid-tones or shadows. Zebras are disabled by default.

For more information, refer to the [Exposure with RED Cameras: False Color and Zebra Tools](http://www.red.com/red-101/exposure-false-color-zebra-tools) article, available at www.red.com/red-101/exposure-false-color-zebra-tools.

ENABLING THE ZEBRA 1 INDICATOR

1. Go to **MENU > MONITORING > TOOLS** and select **ZEBRA 1**.
2. Set a Low IRE of 98.
3. Set a High IRE of 100.

Areas of the image exposed within the IRE range are indicated by red diagonal lines at -45° .

The default settings are Low IRE = 98 and High IRE = 100.

ENABLING THE ZEBRA 2 INDICATOR

1. Go to **MENU > MONITORING > TOOLS** and select **ZEBRA 2**.
2. Set a Low IRE of 41.
3. Set a High IRE of 48.

Areas of the image exposed within the IRE range are indicated by green diagonal lines at 45° .

The default settings are Low IRE = 41 and High IRE = 48.

ZEBRA OVERVIEW

Zebra is a specialty mode that is capable of showing up to two customized overlays with arbitrary IRE ranges. Unlike the other two modes, Zebra indicators appear as diagonal stripes, they are fully configurable, and they have the advantage of preserving a full-color base image.

With traditional video cameras, many used a single zebra to indicate highlight detail. It would often be set at 70% (70 IRE), in part because this is where a white piece of paper would begin to have minimal texture when rendered using a typical contrast curve. Skin tones or skies would be exposed to appear just darker or brighter than these lines. If enabled, a second zebra would typically indicate either mid-tones or shadows. For deep shadows, you can set the second indicator to below 10% intensity or 10 IRE, and set the first indicator to highlights above 85 IRE.

However, as with other IRE-based modes, Zebra mode is only applicable for the current ISO settings (such as with SDI output), not for the raw image data. If anything is changed in post-production, the indicators won't be representative of the final output tones. In those situations, Zebra mode is more of a preview and output brightness tool than an exposure tool.

CALIBRATING THE SENSOR

Sensor calibration is a process during which the camera optimizes image quality by ensuring that pixel sensitivity remains consistent throughout the sensor.

WHEN TO CALIBRATE SENSOR

Calibration is required:

- ▶ When shooting in an environment where the temperature is significantly different (+/- 30° F...) from the current calibration.
- ▶ After an extreme change in exposure time (+/- 1/2 sec).
- ▶ After each firmware upgrade.

UPGRADING THE FIRMWARE

Your camera functionality may be upgraded by installing the latest firmware. Make a habit of frequently visiting RED Downloads at www.red.com/downloads to check for new versions of camera firmware, updated operation guides, and post production software.

VERIFYING THE FIRMWARE VERSION

To see the firmware version that is currently installed on your camera, open **MENU > SYSTEM SETTINGS > SYSTEM STATUS > CAMERA INFO**. A higher number reflects a later release.

UPGRADING THE FIRMWARE

Install the most recent firmware. Unless otherwise specified in the release notes, you do not need to upgrade to any firmware in between your current version and the most recent version available online.

NOTE: You must calibrate the sensor after upgrading the camera. For more information, refer to [Calibrating the Sensor](#).

1. Download the most recent firmware for your camera from RED Downloads at www.red.com/downloads.
2. Unzip the firmware zip file.
3. In the unzipped folder, navigate to the **upgrade** folder
4. Copy the **upgrade** folder and its contents to the root level of the CFast media card directory.
5. Eject or unmount the CFast media card from your computer and remove it.
6. Ensure that the camera is turned off.
7. Insert the CFast media card in the camera.
8. Turn on the camera.
9. From the camera UI, navigate to the [Maintenance Menu](#).
10. From the Maintenance menu, tap the **OK** button next to **Upgrade**.
11. During the upgrade, the fans run at high speed and the **Firmware Upgrade** progress screen displays.
12. The camera displays the **Shutting Down...** message and reboots.

13. The camera restarts and displays the **Initializing...** message.
14. The camera displays the **Two-Stage Firmware Upgrade** progress screen.
15. The camera displays the **Shutting Down...** message and reboots again.
16. The new **Initializing** progress screen displays.
17. The **Firmware Upgrade** progress screen displays.
18. The **Firmware Upgrade** success message screen displays with a **Restart** button.
19. Tap the **Restart** button. The Shutting Down message displays.
20. The camera restarts displaying the BETA warning, and then the new **Initializing** progress screen displays.
21. When this is your first time upgrading the firmware, a pop-up menu opens with the Software License Agreement (SLA). Select **Agree**. If you do not agree to the SLA, the camera cannot be used. The SLA continues to display until it is accepted.
22. Verify that the firmware version listed matches the firmware version that you downloaded.
23. Reformat the CFast media card before recording.

SYSTEM MAINTENANCE

All RED products are designed for rugged durability, but precision instruments demand proper care. Follow the instructions in this section to clean, maintain, and store your devices.

WARNING: DO NOT rinse or immerse the camera or other accessories in water. Keep dry at all times.

WARNING: DO NOT use soaps, detergents, ammonia, acetone, alkaline cleaners, abrasive cleaning compounds, or solvents. These substances may damage lens coatings and electronic circuitry.

WARNING: DO NOT use an excess of cleaning solution.

WARNING: DO NOT reuse swabs or wipes.

WARNING: DO NOT attempt to clean the sensor or optical cavity for any reason. If the sensor becomes dirty, submit a Support ticket at <https://support.red.com>.

WARNING: DO NOT attempt to modify, dismantle, or open the camera, lens, or other accessory as doing so may expose you to electric shock and serious injury. There are no user-serviceable parts inside. Alteration or repairs made to the camera or accessories, except by a RED authorized service facility, voids all warranties.

WARNING: Use caution with compressed air and gas dusters, since the high pressure, oily residue, cold air, particulates, and moisture may cause damage. You may use a filtered, non-residue gas duster to clean non-critical areas, such as around the fans and other recesses on the exterior of the camera. Damage to the camera or other components of the camera system caused by using compressed air or gas dusters is not covered under warranty.

WARNING: DO NOT use compressed air and gas dusters on the sensor or on any optics.

WARNING: DO NOT use compressed air and gas dusters on or around the integrated microphones on the front of the camera.

EXTERIOR SURFACES

- ▶ Use a filtered, non-residue gas duster to clean non-critical areas, such as around the fans and other recesses on the exterior of the camera.
- ▶ Clean with a dry lint-free cloth. When cleaning your camera and accessories, remember that the devices are not waterproof and moisture can damage electronic circuitry.

STORAGE

WARNING: DO NOT store the camera or accessories in any place with extreme temperatures, direct sunlight, high humidity, severe vibration, or strong magnetic fields.

LCD SCREEN

This section explains how to clean the built-in LCD screen.

APPROVED LCD SCREEN CLEANERS

Use only the following products to clean the built-in LCD screen:

- ▶ Ionized rubber air bulb
- ▶ Delkin Devices Sensor Solution®
- ▶ Lens swabs
- ▶ Dry optical wipes

NOTE: Before cleaning the screen with swabs or wipes and a cleaning solution, ALWAYS use an ionized rubber air bulb to remove any solid particles. Cleaning the screen without removing solid particles increases the risk of scratching the screen.

PROHIBITED LCD SCREEN CLEANERS

DO NOT use any of the items listed below to clean the built-in LCD screen. These products have not been tested on RED products and may cause damage or streaking.

- ▶ Compressed air
- ▶ Gas dusters
- ▶ Solvents
- ▶ Rubbing alcohol
- ▶ Isopropyl alcohol
- ▶ Windex
- ▶ Pancro Professional Lens Cleaner (or equivalent)
- ▶ Third-party cleaning kits
- ▶ Pre-packaged lens cleaner containing any additives, such as detergent, anti-static compounds, or fragrance

WARNING: Damage to the LCD screen or other components of the camera system caused by using prohibited cleaners is not covered under warranty.

WATER DAMAGE

If your device has come in contact with water or you suspect water damage, submit a Support ticket at <https://support.red.com> immediately.

WARNING: DO NOT attempt to power any device that may have water damage.

WARNING: DO NOT place the device in a container of rice, silica gel, or desiccant packets in an attempt to dry the device.

6. TROUBLESHOOTING

GENERAL TROUBLESHOOTING TIPS

This section describes general troubleshooting tips:

- ▶ Check the current firmware on the camera. If newer firmware is available from RED, download and install that firmware.
- ▶ Check the [Known Issues List](#) to see if the issue has already been identified by RED.
- ▶ Turn the camera off and on.
- ▶ Try using fresh media.
- ▶ Try different cables and make sure that the cables are properly attached.
- ▶ Remove all accessories and then re-attach them one-by-one. This process may help you identify whether the issue is specific to a particular accessory.
- ▶ Reset the camera to its default settings.

CONTACT SUPPORT

If you are unable to resolve an issue, submit a [Support ticket](#). Include the following with the request:

- ▶ A Log file. For more information, go to [Save Log](#).
- ▶ A list of devices, lens, and third-party accessories that were attached when the issue occurred.
- ▶ The camera power source used when the issue occurred (include battery types, power devices, and power cables).
- ▶ A description of the issue that occurred.

7. MECHANICAL DRAWINGS

NOTE: Dimensions are shown in mm.

FRONT VIEW

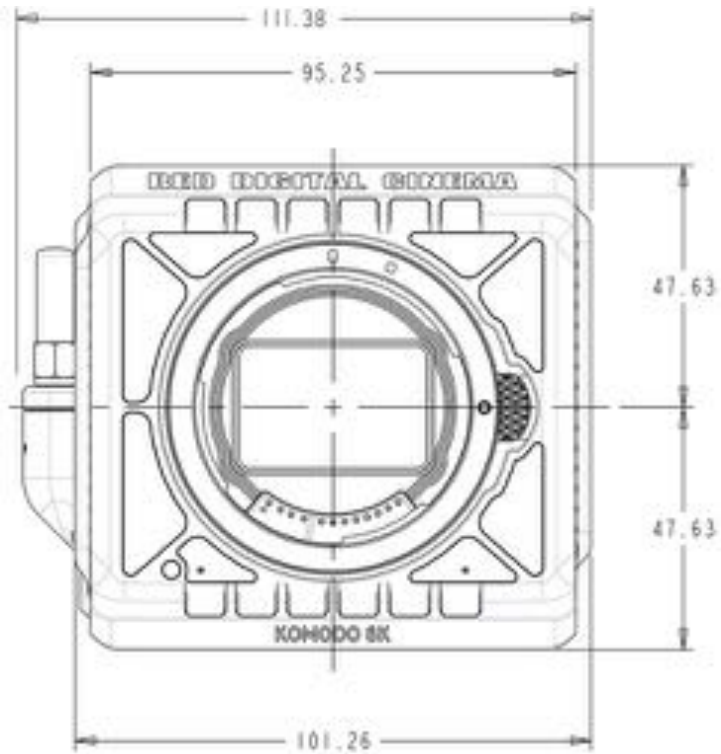

Figure: Camera Front View

BACK VIEW

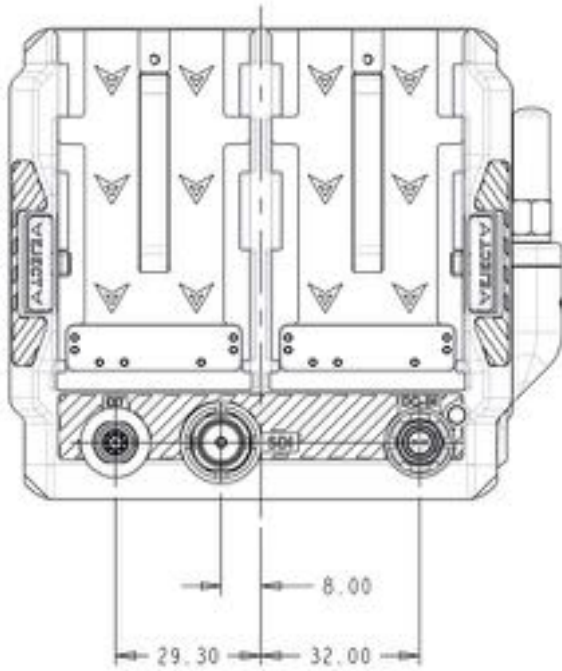

Figure: Camera Back View

RIGHT SIDE VIEW

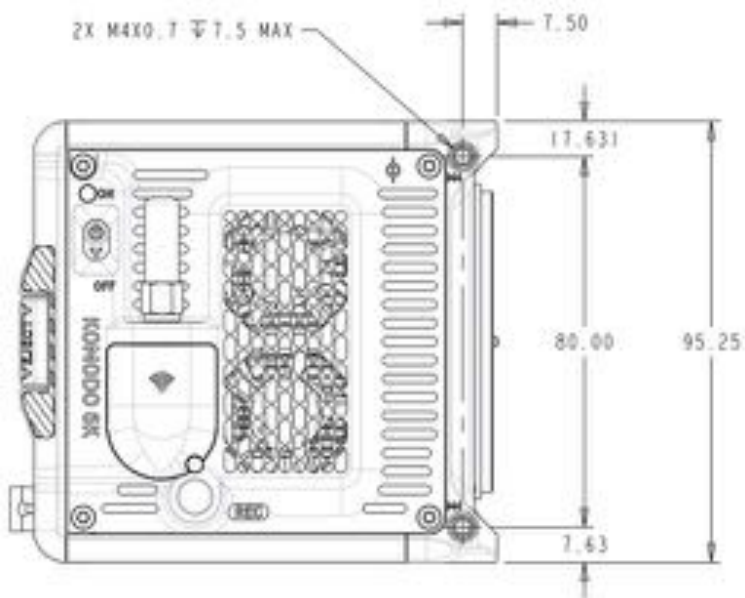

Figure: Camera Side View (Right)

LEFT SIDE VIEW

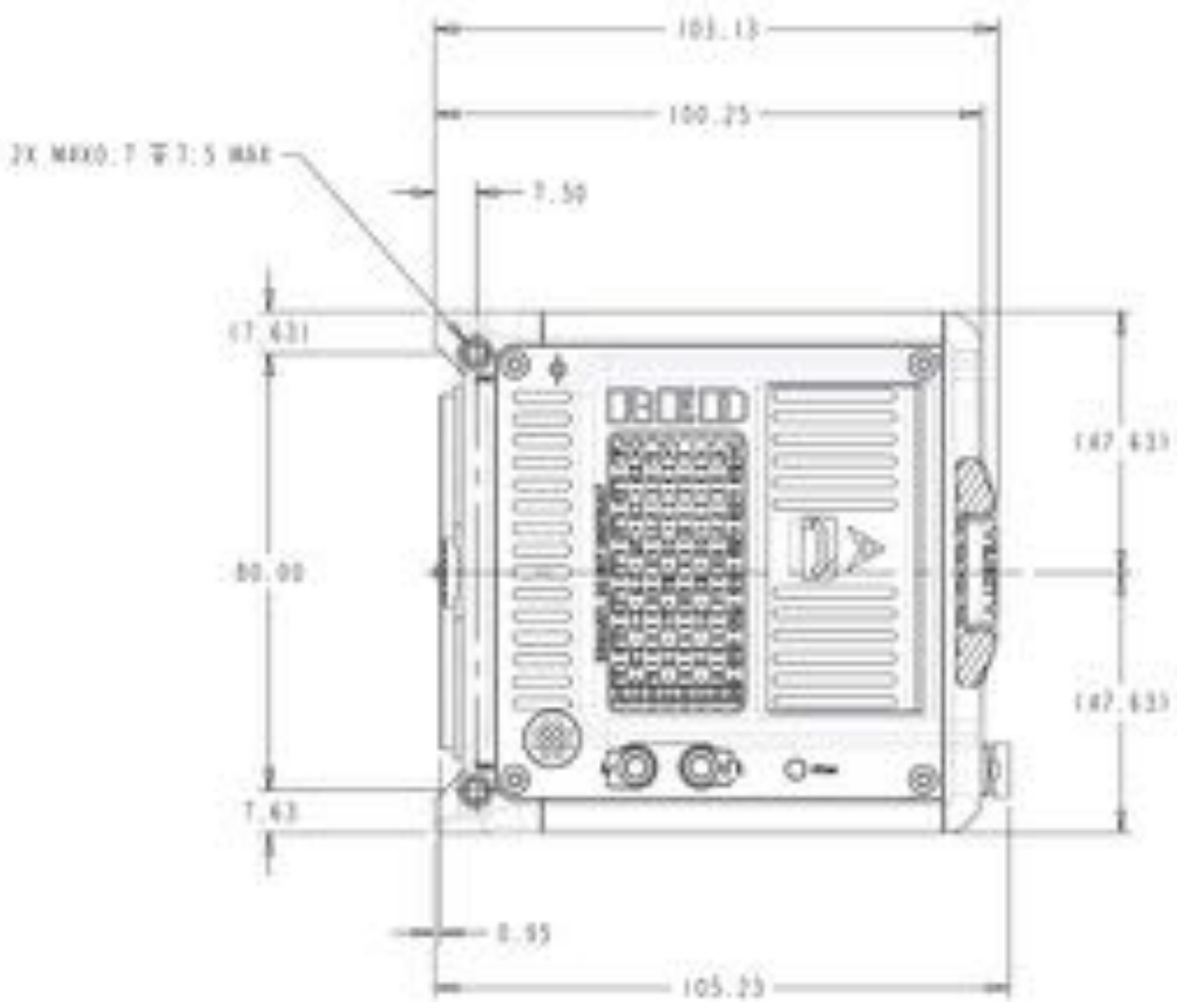

Figure: Camera Side View (Left)

TOP VIEW

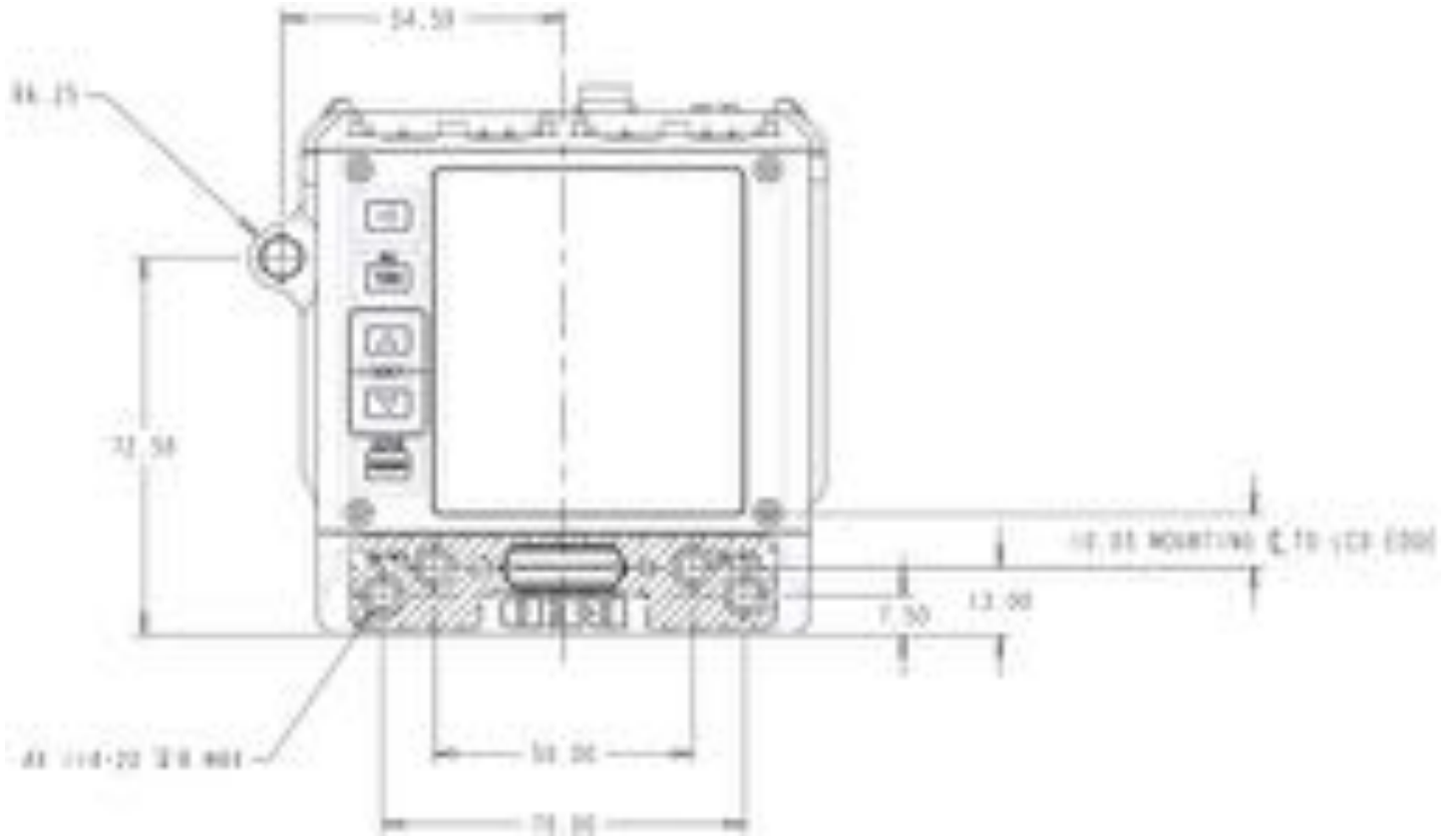

Figure: Camera Top View

BOTTOM VIEW

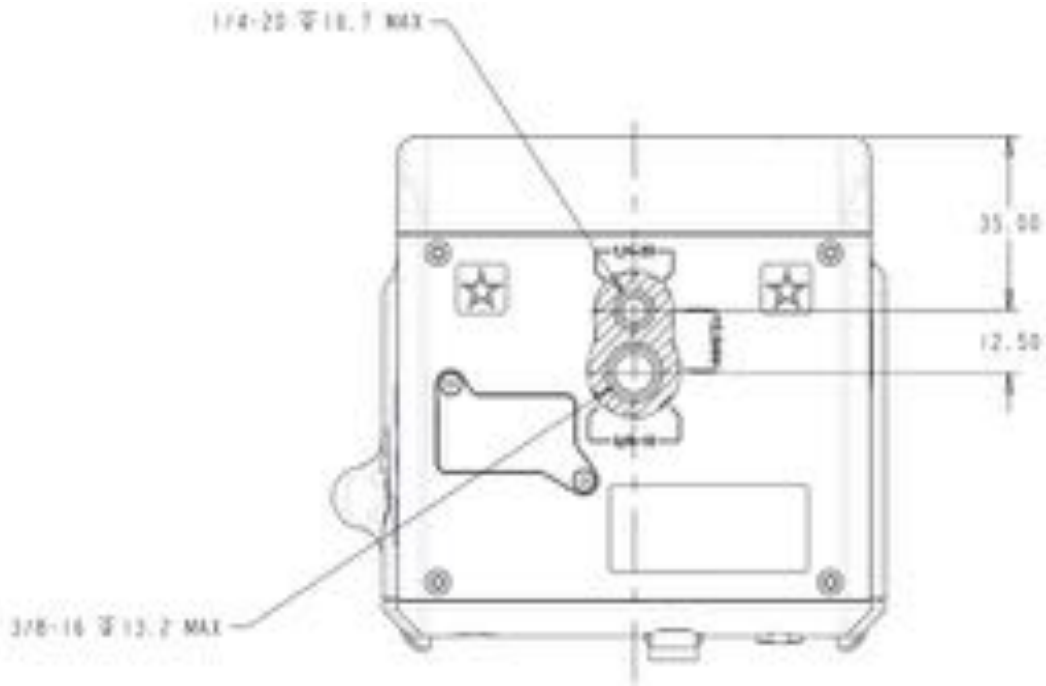

Figure: Camera Bottom View

EXTENSION PORT

The Extension port is located on the back of the camera body.



The 9-pin 0B ODU Extension port supports RS-232 RX, RS-232 TX, and a General Purpose Input (GPI) trigger (active-low switch closure), General Purpose Output (GPO), Timecode, and Genlock. The connector also offers auxiliary 5 Volt power out, with a maximum sustained current draw of 500 mA.

To operate the GPI contact closure style trigger, short Pin 6 (GPI) to Pin 9 (ground).

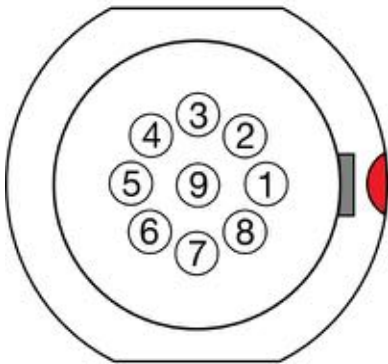

Figure: Front Face of the Extension port (Looking at the Camera)

NOTE: The required mating connector is 9-Pin 0L Straight Plug Connector (SX0L0X-P09MCC0-0001).

9-PIN 0B ODU AUXILIARY PORT PINOUT

PIN	NAME	DESCRIPTION
1	5 V AUX	5 Volt AUX (500 mA Max) enabled using the Power menu
2	Timecode Out	Timecode Out – SMPTE 12M
3	GPO	General Purpose Out, Tally or Sync, 3.3 Volt Logic Level
4	UART TX	RS-232 Transmit
5	UART RX	RS-232 Receive
6	GPI	General Purpose In, 3.3 Volt Logic Level ¹
7	Timecode In	Timecode In – SMPTE 12M
8	Genlock	Tri-Level Genlock In (SMPTE 296M and 274M)
9	GND	Signal and Power Ground

1. The signal path includes a resistor pulling the signal high, which is designed to work with a closure switch connected to GND.

DC-INPUT

The DC-IN port is located on the back of the camera body.



Connect the 2-pin 0B ODU DC power Adaptor plug to this port to provide the camera with continuous DC power. The RED power Adaptor provides DC power to operate the camera and to recharge the attached **Batteries**.

NOTE: The camera cannot charge batteries while it is turned on.

SPECIFICATIONS

The 2-Pin 0B connector accepts unregulated (+) 7 to 17 Volts (V) Direct Current (DC) power. Power consumption for the camera alone is approximately 27 Watts.

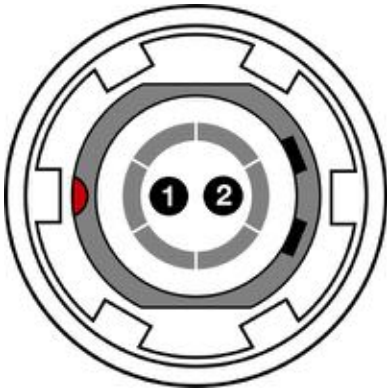

Figure: Front Face of DC-IN Port (looking at the back of the camera)

ODU 0B 2-PIN CONNECTOR

PIN	SIGNAL	DESCRIPTION	DIRECTION
1	7 to 17 Volts DC	Power to the camera and batteries	In
2	GROUND	Common ground	N/A

CTRL (RS-232 CONTROL)

The CTRL port is located on the back of the **KOMODO Expander Module**.



Connect to this port to provide communication between the camera and external devices.

SPECIFICATIONS

The 4-Pin 00B CTRL Connector supports RS-232 remote control for 3D camera communication and third-party metadata ingest applications.

The General Purpose Out (GPO) tally presents 3.3 V at a maximum of 0.04 A between pins 1 and 3. When used as a record tally, the rising edge of the pulse indicates the start of record, and the falling edge represents the end of record.

For more information about controlling the camera using RS-232, download the **R.C.P.™ SDK**, available at www.red.com/developers.

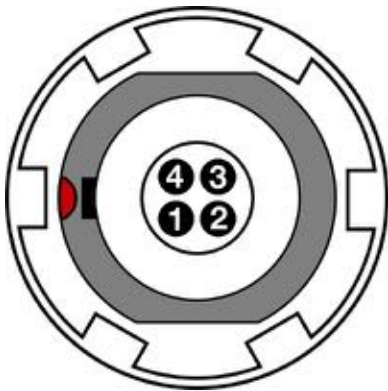

Figure: Front Face of CTRL Port (looking at the back of the **KOMODO Expander Module**)

ODU 00B 4-PIN CONNECTOR

PIN	SIGNAL	DESCRIPTION	DIRECTION
1	GROUND	Common ground	N/A
2	232 RX	RS-232 receive	In
3	SS/GPO	Shutter sync and general purpose output	Out
4	232 TX	RS-232 transmit	Out

8. MENU MAP

